

NAT'L INST. OF STAND & TECH R.I.C.

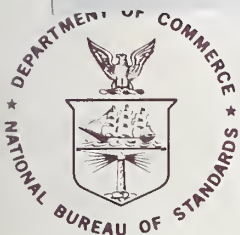

A11105 477090



# NBS TECHNICAL NOTE 910-1

U.S. DEPARTMENT OF COMMERCE / National Bureau of Standards

## SELF-STUDY MANUAL ON OPTICAL RADIATION MEASUREMENTS

Part I--Concepts  
Chapters 1 to 3

QC

100

.45753

no. 910-1

1976

c. 2

## NATIONAL BUREAU OF STANDARDS

The National Bureau of Standards<sup>1</sup> was established by an act of Congress March 3, 1901. The Bureau's overall goal is to strengthen and advance the Nation's science and technology and facilitate their effective application for public benefit. To this end, the Bureau conducts research and provides: (1) a basis for the Nation's physical measurement system, (2) scientific and technological services for industry and government, (3) a technical basis for equity in trade, and (4) technical services to promote public safety. The Bureau consists of the Institute for Basic Standards, the Institute for Materials Research, the Institute for Applied Technology, the Institute for Computer Sciences and Technology, and the Office for Information Programs.

**THE INSTITUTE FOR BASIC STANDARDS** provides the central basis within the United States of a complete and consistent system of physical measurement; coordinates that system with measurement systems of other nations; and furnishes essential services leading to accurate and uniform physical measurements throughout the Nation's scientific community, industry, and commerce. The Institute consists of the Office of Measurement Services, the Office of Radiation Measurement and the following Center and divisions:

Applied Mathematics — Electricity — Mechanics — Heat — Optical Physics — Center for Radiation Research: Nuclear Sciences; Applied Radiation — Laboratory Astrophysics<sup>2</sup> — Cryogenics<sup>2</sup> — Electromagnetics<sup>2</sup> — Time and Frequency<sup>2</sup>.

**THE INSTITUTE FOR MATERIALS RESEARCH** conducts materials research leading to improved methods of measurement, standards, and data on the properties of well-characterized materials needed by industry, commerce, educational institutions, and Government; provides advisory and research services to other Government agencies; and develops, produces, and distributes standard reference materials. The Institute consists of the Office of Standard Reference Materials, the Office of Air and Water Measurement, and the following divisions:

Analytical Chemistry — Polymers — Metallurgy — Inorganic Materials — Reactor Radiation — Physical Chemistry.

**THE INSTITUTE FOR APPLIED TECHNOLOGY** provides technical services to promote the use of available technology and to facilitate technological innovation in industry and Government; cooperates with public and private organizations leading to the development of technological standards (including mandatory safety standards), codes and methods of test; and provides technical advice and services to Government agencies upon request. The Institute consists of the following divisions and Centers:

Standards Application and Analysis — Electronic Technology — Center for Consumer Product Technology: Product Systems Analysis; Product Engineering — Center for Building Technology: Structures, Materials, and Life Safety; Building Environment; Technical Evaluation and Application — Center for Fire Research: Fire Science; Fire Safety Engineering.

**THE INSTITUTE FOR COMPUTER SCIENCES AND TECHNOLOGY** conducts research and provides technical services designed to aid Government agencies in improving cost effectiveness in the conduct of their programs through the selection, acquisition, and effective utilization of automatic data processing equipment; and serves as the principal focus within the executive branch for the development of Federal standards for automatic data processing equipment, techniques, and computer languages. The Institute consists of the following divisions:

Computer Services — Systems and Software — Computer Systems Engineering — Information Technology.

**THE OFFICE FOR INFORMATION PROGRAMS** promotes optimum dissemination and accessibility of scientific information generated within NBS and other agencies of the Federal Government; promotes the development of the National Standard Reference Data System and a system of information analysis centers dealing with the broader aspects of the National Measurement System; provides appropriate services to ensure that the NBS staff has optimum accessibility to the scientific information of the world. The Office consists of the following organizational units:

Office of Standard Reference Data — Office of Information Activities — Office of Technical Publications — Library — Office of International Relations — Office of International Standards.

<sup>1</sup> Headquarters and Laboratories at Gaithersburg, Maryland, unless otherwise noted; mailing address Washington, D.C. 20234.

<sup>2</sup> Located at Boulder, Colorado 80302.

# Self-Study Manual on Optical Radiation Measurements: Part I--Concepts, Chapters 1 to 3

---

to Technical Note, no. 913-1.

NATIONAL BUREAU  
OF STANDARDS  
LIBRARY

APR 5 1976

30180

30180

101733

no. 7111

1075

22

Fred E. Nicodemus, Editor

Optical Physics Division  
Institute for Basic Standards  
National Bureau of Standards  
Washington, D. C. 20234

Chapter 1. Introduction, F. E. Nicodemus, H. J. Kostkowski, and A. T. Hattenburg

Chapter 2. Distribution of Optical Radiation with Respect to Position and Direction--Radiance, F. E. Nicodemus, and H. J. Kostkowski

Chapter 3. Spectral Distribution of Optical Radiation, F. E. Nicodemus and H. J. Kostkowski



---

U.S. DEPARTMENT OF COMMERCE, Elliot L. Richardson, *Secretary*

James A. Baker, III, *Under Secretary*

Dr. Betsy Ancker-Johnson, *Assistant Secretary for Science and Technology*

NATIONAL BUREAU OF STANDARDS, Ernest Ambler, *Acting Director*

Issued March 1976

**National Bureau of Standards Technical Note 910-1**

Nat. Bur. Stand. (U.S.), Tech. Note 910-1, 93 pages (Mar. 1976)

CODEN: NBTNAE

U.S. GOVERNMENT PRINTING OFFICE  
WASHINGTON: 1976

---

For sale by the Superintendent of Documents, U.S. Government Printing Office, Washington, D.C. 20402  
(Order by SD Catalog No. C13.46:910-1). Price \$ (Add 25 percent additional for other than U.S. mailing).

## PREFACE

This is the initial publication of a new series of Technical Notes (910) entitled "Self-Study Manual on Optical Radiation Measurements." It contains the first three chapters of this Manual. Additional chapters will be published, similarly, as they are completed. The Manual is being written by the Optical Radiation Section of NBS. In addition to writing some of the chapters, themselves, Fred E. Nicodemus is the Editor of the Manual and Henry J. Kostkowski, Chief of the Section, heads the overall project.

In recent years, the economic and social impact of radiometric measurements (including photometric measurements) has increased significantly. Such measurements are required in the manufacture of cameras, color TV's, copying machines, and solid-state lamps (LED's). Ultraviolet radiation is being used extensively for the polymerization of industrial coatings, and regulatory agencies are concerned with its effects on the eyes and skin of workers. On the other hand, phototherapy is usually the preferred method for the treatment of jaundice in the newborn. Considerable attention is being given to the widespread utilization of solar energy. These are just a few examples of present day applications of optical radiation. Most of these applications would benefit from simple measurements of one to a few per cent uncertainty and, in some cases, such accuracies are almost essential. But this is rarely possible. Measurements by different instruments or techniques commonly disagree by 10% to 50%, and resolving these discrepancies is time-consuming and costly.

There are two major reasons for the large discrepancies that occur. One is that optical radiation is one of the most difficult physical quantities to measure accurately. Radiant power varies with the radiation parameters of position, direction, wavelength, time, and polarization. The responsivity of most radiometers also varies with these same radiation parameters and with a number of environmental and instrumental parameters, as well. Thus, the accurate measurement of optical radiation is a difficult multi-dimensional problem. The second reason is that, in addition to this inherent difficulty, there are few measurement experts available. Most of the people wanting to make optical radiation measurements have not been trained to do so. Few schools have had programs in this area and tutorial and reference material that can be used for self-study is only partially available, is scattered throughout the literature, and is generally inadequate. Our purpose in preparing this Self-Study Manual is to make that information readily accessible in one place and in systematic, understandable form.

The idea of producing such a manual at NBS was developed by one of us (HJK) in the latter part of 1973. Detailed planning got under way in the summer of 1974 when a full-time editor (FEN) was appointed. The two of us worked together for about one year developing an approach and format while writing and rewriting several drafts of the first few chapters. These are particularly important because they will serve as a model for the rest of the Manual. During this period, a draft text for the first four chapters was distributed, along with a questionnaire, for comment and criticism to some 200 individuals representing virtually every technical area interested in the Manual. About 50 replies were received, varying widely in the reactions and suggestions expressed. Detailed discussions were also held with key individuals, including most of the Section staff, particularly those that will be writing some of the later chapters. In spite of the very wide range of opinions encountered, all of this feedback has provided valuable guidance for the final decisions about objectives, content, style, level of presentation, etc.

In particular, we have been able to arrive at a clear solution to difficult questions about the level of presentation. Both of us started out with the firm conviction that, with enough time and effort, we should be able to present the subject so that readers with the equivalent of just elementary college mathematics and science could easily follow it. That conviction was based on our experience of success in explaining the subtleties of radiometric measurements to technicians at that level. What we failed to consider, however, was that, in making such explanations to individuals we always were able to relate what we said to the particular background and immediate problem of the individual. That's just not possible in a text intended for broad use by workers in astronomy, mechanical heat-transfer engineering, illumination engineering, photometry, meteorology, photo-biology and photo-chemistry, optical pyrometry, remote sensing, military infrared applications, etc. To deal directly and explicitly with each individual's problems in a cook-book approach

would require an impossibly large and unwieldy text. So we must fall back on general principles which immediately and unavoidably require more knowledge and familiarity with science and mathematics, at the level of a bachelor's degree in some branch of science or engineering, or the equivalent in other training and experience.

In its present form, the Manual is a definitive tutorial treatment of the subject that is complete enough for self instruction. This is what is meant by the phrase "self-study" in the title. The Manual does not contain explicitly programmed learning steps as that phrase sometimes denotes. In addition, through detailed, yet concise, chapter summaries, the Manual is designed to serve also as a convenient and authoritative reference source. Those already familiar with a topic should turn immediately to the summary at the end of the appropriate chapter. They can determine from that summary what, if any, of the body of the chapter they want to read for more details.

The basic approach and focal point of the treatment in this Manual is the measurement equation. We believe that every measurement problem should be addressed with an equation relating the quantity desired to the data obtained through a detailed characterization of the instruments used and the radiation field observed, in terms of all of the relevant parameters. The latter always include the radiation parameters, as well as environmental and instrumental parameters, as previously pointed out. The objective of the Manual is to develop the basic concepts and characterizations required so that the reader will be able to use this measurement-equation approach. It is our belief that this is the only way that uncertainties in the measurement of optical radiation can generally be limited to one, or at most a few, per cent.

Currently, the Manual deals only with the classical radiometry of incoherent radiation. The basic quantitative relations for the propagation of energy by coherent radiation (e.g., laser beams) are just being worked out [1,2,3,4].<sup>1</sup> Without that basic theory, a completely satisfactory general treatment of the measurement of coherent (including partially coherent) optical radiation is not possible. Accordingly, in spite of the urgent need for improved measurements of laser radiation, we won't attempt to deal with it now. Possibly this situation will be changed before the current effort has been completed and a supplement on laser measurements can be added.

As stated above, we first hoped to prepare this Manual on a more elementary level but found that it was impossible to avoid making use of both differential and integral calculus of more than one variable. However, to help those that might be a bit "rusty" with such mathematics, we go back to first principles each time a mathematical concept or procedure beyond those of simple algebra or trigonometry is introduced. This should also throw additional light on the physical and geometrical relationships involved. Where it seems inappropriate to do this in the text, we cover such mathematical considerations in appendices. It is also assumed that the reader has had an introductory college course in physics, or the equivalent.

The Manual is being organized into three Parts, as follows:

#### Part I. Concepts

Step by step build up of the measurement equation in terms of the radiation parameters, the properties and characteristics of sources, optical paths, and receivers, and the environmental and instrumental parameters. Useful quantities are defined and discussed and their relevance to various applications in many different fields (photometry, heat-transfer engineering, astronomy, photo-biology, etc.) is indicated. However, discussions of actual devices and measurement situations in this Part are mainly for purposes of illustrating concepts and basic principles.

#### Part II. Instrumentation

Descriptions, properties, and other pertinent data concerning typical instruments, devices, and components involved in common measurement situations. Included is material

---

<sup>1</sup>Figures in brackets indicate literature references listed at the end of the Technical Note.

dealing with sources, detectors, filters, atmospheric paths, choppers (and other types of optical modulators), prisms, gratings, polarizers, radiometers, photometers, spectro-radiometers, spectrophotometers, etc.

### Part III. Applications

Measurement techniques for achieving a desired level of, or improving, the accuracy of a measurement. Included will be a very wide variety of examples of environmental and instrumental parameters with discussion of their effects and how to deal with them. This is where we deal with real measurements in the real world. The examples will also be drawn from the widest possible variety of areas of application in illumination engineering, radiative heat transfer, military infrared devices, remote sensing, meteorology, astronomy, photo-chemistry and photo-biology, etc.

Individual chapter headings have been assigned only to the first five chapters:

- Chapter 1. Introduction
- Chapter 2. Distribution of Optical Radiation with respect to Position and Direction -- Radiance
- Chapter 3. Spectral Distribution of Optical Radiation
- Chapter 4. Optical Radiation Measurements -- a Measurement Equation
- Chapter 5. More on the Distribution of Optical Radiation with respect to Position and Direction

Other subjects definitely planned for Part I are thermal radiation, photometry, distribution with respect to time, polarization, diffraction, and detector concepts. It is not our intention, however, to try to complete all of Part I before going on to Parts II and III. In fact, because we realize that a great many readers are probably most interested in the material on applications to appear in Part III, we will try to complete and publish some chapters in Parts II and III just as soon as adequate preparation has been made in the earlier chapters of Part I. However, because our approach to radiometry differs so much from the traditional treatment, we feel that unnecessary confusion and misunderstanding can be avoided if at least the first nine chapters of Part I are published first and so are available to readers of later chapters.

Finally, we invite the reader to submit comments, criticisms, and suggestions for improving future chapters in this Manual. In particular, we welcome illustrative examples and problems from as widely different areas of application as possible.

As previously stated, we are indebted to a great many individuals for invaluable "feedback" that has helped us to put this text together more effectively. Notable are the inputs and encouragement from the Council on Optical Radiation Measurements (CORM), especially the CORM Coordinators, Richard J. Becherer, John Eby, Franc Grum, Alton R. Karoli, Edward S. Steeb, and Robert B. Watson, and the Editor of *Electro-Optical Systems Design*, Robert D. Compton. In addition, for editorial assistance, we are grateful to Donald A. McSparron, Joseph C. Richmond, and John B. Shumaker, and particularly to Albert T. Hattenburg.

We are especially grateful to Mrs. Betty Castle for the skillful and conscientious effort that produced the excellent typing of this difficult text. We also want to thank Henry J. Zoranski for his capable help with the figures.

Fred E. Nicodemus, Editor

Henry J. Kostkowski, Chief,  
Optical Radiation Section.

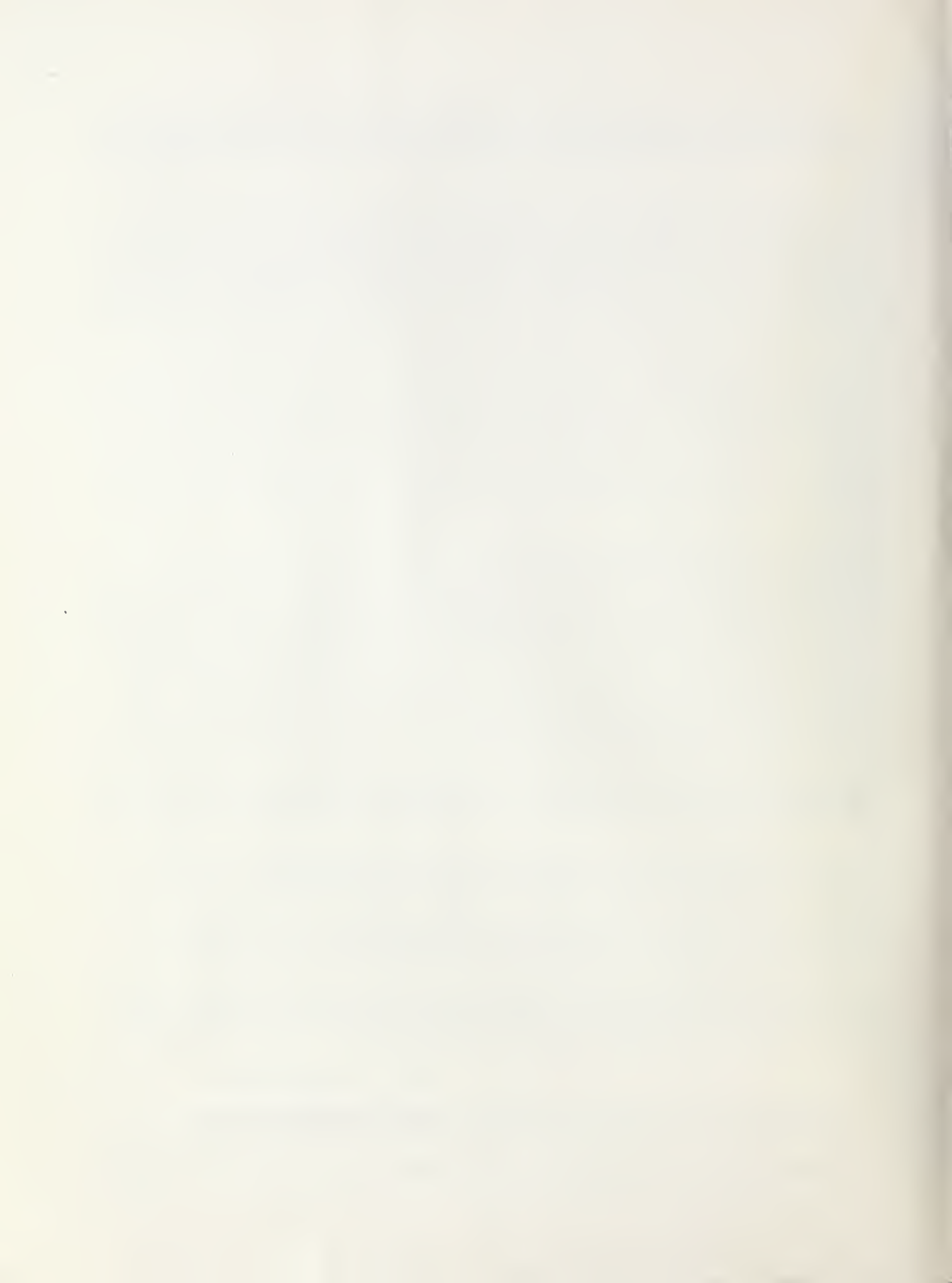



## Contents

		Page
Part I.	Concepts . . . . .	1
	Chapter 1. Introduction . . . . .	1
	In this CHAPTER . . . . .	1
	OPTICAL RADIATION . . . . .	1
	The MEASUREMENT EQUATION . . . . .	4
	UNITS and NOMENCLATURE . . . . .	7
	SUMMARY of CHAPTER 1 . . . . .	8
	Chapter 2. Distribution of Optical Radiation with respect to Position and Direction -- Radiance . . . . .	10
	In this CHAPTER . . . . .	10
	The OPTICAL-RAY APPROACH . . . . .	10
	RADIANCE (through two apertures) . . . . .	12
	RAY RADIANCE (at a point in a direction) . . . . .	19
	The ELEMENT of FLUX and the GEOMETRICAL INVARIANCE of RADIANCE . . . . .	23
	APPLICATIONS of RADIANCE INVARIANCE . . . . .	26
	An EXAMPLE of RADIANCE INVARIANCE . . . . .	29
	GEOMETRICAL INVARIANCE of THROUGHPUT . . . . .	30
	OPTICAL PROPAGATION -- INTERACTIONS with MATTER . . . . .	37
	TRANSFORMATION from KNOWN RADIANCE DISTRIBUTION to FLUX at ANOTHER LOCATION . . . . .	40
	SUMMARY of CHAPTER 2 . . . . .	42
	Chapter 3. Spectral Distribution of Optical Radiation . . . . .	45
	In this CHAPTER . . . . .	45
	SPECTRAL RADIANCE . . . . .	45
	GEOMETRICAL INVARIANCE of SPECTRAL RADIANCE . . . . .	51
	TOTAL FLUX in a RADIATION BEAM . . . . .	52
	TRANSFORMATION from KNOWN SPECTRAL-RADIANCE DISTRIBUTION to FLUX at ANOTHER LOCATION . . . . .	53
	REMAINING RADIATION PARAMETERS -- TIME and POLARIZATION' . . . . .	54
	SUMMARY of CHAPTER 3 . . . . .	54

	Page
Appendix 1. Units and Unit Symbols . . . . .	56
Appendix 2. Spherical Coordinates and Geometrical Relationships . . . . .	62
SPHERICAL COORDINATES (solid polar coordinates) . . . . .	62
A SOLID ANGLE . . . . .	62
A SOLID ANGLE in SPHERICAL COORDINATES . . . . .	67
A PROJECTED SOLID ANGLE . . . . .	70
OTHER SOLID-ANGLE MEASURES and/or APPROXIMATIONS . . . . .	77
References . . . . .	81

List of Figures

1.1	Spectrum of electromagnetic waves . . . . .	2
1.2	A sophisticated spectroradiometer configuration for precision laboratory measurements of spectral radiance . . . . .	5
1.3	Lunar radiation measurement configuration . . . . .	6
2.1	Rays from lamp source to detector-receiver . . . . .	11
2.2	Experiment to develop the concept of <u>radiance</u> . . . . .	13
2.3	Tilted apertures . . . . .	14
2.4	Notation for subdivided apertures . . . . .	17
2.5	Computation of flux $\Delta\Phi_{14}$ . . . . .	18
2.6	The <u>solid angle</u> $\Delta\omega_{12}$ subtended at $\Delta A_1$ by $\Delta A_2$ . . . . .	20
2.7	Geometry of ray-surface intersection (for the definition of <u>radiance</u> ). . . . .	22
2.8(a)	A single ray . . . . .	24
2.8(b)	An <u>elementary beam</u> of radiation . . . . .	24
2.9	Invariance of <u>basic radiance</u> along a refracted ray . . . . .	27
2.10	Sources A, B, or C, all of the same (uniform, isotropic) radiance L, are indistinguishable when "viewed" from P (only one present at a time) . . . . .	31
2.11	Slide-projector throughput . . . . .	35
2.12	Burning-glass throughput . . . . .	36
2.13	Transmittance of ray path . . . . .	39
3.1	Large variations of radiometric quantities with respect to wavelength . . . . .	46

	Page
3.2	Ideal filter set with spectral transmittances all centered about the same $\lambda_c$ . . . . . 48
3.3	Spectral distribution of emission for three typical light sources . . . . . 50
A2-1	Spherical and rectangular coordinates of $P(\rho, \theta, \phi) = P(x, y, z)$ . . . . . 63
A2-2	The same plane angle $\theta$ is subtended at O by: <ol style="list-style-type: none"> <li>1. the circular arc CD</li> <li>2. the straight line EF</li> <li>3. the curve <math>E'F'</math></li> <li>4. the plane figure <math>E''F''</math> . . . . . 64</li> </ol>
A2-3	A solid angle . . . . . 66
A2-4	An element of solid angle $d\omega = dA_s/\rho^2 = \sin\theta \cdot d\theta \cdot d\phi$ [sr] . . . . . 68
A2-5	A right circular cone about the polar axis with half-vertex angle $\theta_h$ . . . . . 71
A2-6	An arbitrarily oriented surface element $dA_2$ subtends a solid-angle element $d\omega_{12}$ at $dA_1$ at a distance D . . . . . 72
A2-7	Sketch of Cassegrain-type optics . . . . . 73
A2-8	Geometrical construction for measures of an element of <u>solid angle</u> $d\omega$ and an element of <u>projected solid angle</u> $d\Omega$ . . . . . 75
A2-9	Wiener's construction for measures of the <u>solid angle</u> $\omega$ and the <u>projected solid angle</u> $\Omega$ subtended at $dA$ by an irregular object . . . . . 76
A2-10	Measures of an element of <u>solid angle</u> $d\omega$ and an element of <u>projected solid angle</u> $d\Omega$ (unit-diameter tangent sphere construction) . . . . . 78

## List of Tables

		Page
A1-1	SI Base Units . . . . .	56
A1-2	SI Prefixes . . . . .	57
A1-3	SI Derived Units for Radiometry . . . . .	58
A1-4	SI Derived Units for Photometry . . . . .	59
A1-5	Some Additional non-SI Photometric Units . . . . .	60
A1-6	Units for Photon-Flux Radiometry . . . . .	61
A2-1	Values of projected solid angle $\Omega$ , solid angle $\omega$ , common approximations $\pi \cdot \tan^2 \theta_h$ and $\pi \cdot \theta_h^2$ , and related measures of "light-gathering power" (f-number or relative aperture $f/\#$ , and numerical aperture N.A.) for right circular cones of half-vertex (polar) angle $\theta_h$ about the normal to a reference surface (aperture stop, field stop, etc.), i.e., about the optic axis of a cylindrically symmetric optical system . . . . .	80

## SELF-STUDY MANUAL on OPTICAL RADIATION MEASUREMENTS

This is the initial publication of a new series of Technical Notes (910) entitled "Self-Study Manual on Optical Radiation Measurements." It contains the first three chapters of this Manual. Additional chapters will be published, similarly, as they are completed. The Manual is a definitive tutorial treatment of the measurement of incoherent optical radiation that is complete enough for self instruction. Detailed chapter summaries make it also a convenient authoritative reference source.

The first chapter is an introduction that includes a description of optical radiation and the ray approach to its treatment in this Manual (based on geometrical optics), a discussion of relevant parameters and their use in a measurement equation as a systematic technique for analyzing measurement problems, and a presentation of the system of units and nomenclature used.

The second chapter, on the distribution of optical radiation with respect to position and direction, introduces the basic radiometric quantity, radiance, and its important invariance properties. It is shown how to determine the total power in a beam from the radiance distribution and to determine the distribution of radiance at any surface, through which the beam passes, in terms of the distribution at any other surface that also intersects the entire beam.

The third chapter, on the spectral distribution of optical radiation, develops the concept of spectral radiance. Its invariance properties and the evaluation of flux in a beam from a known distribution of spectral radiance are developed in a treatment paralleling that for radiance in Chapter 2.

These are the first chapters of Part I, in which are developed the basic concepts, essential for the subsequent discussions of instrumentation in Part II, and of applications in Part III.

Key Words: Optical radiation measurement; photometry; radiometry; spectroradiometry.

### Part I. Concepts

#### Chapter 1. Introduction

by Fred E. Nicodemus, Henry J. Kostkowski, and  
Albert T. Hattenburg

In this CHAPTER. We describe optical radiation and the ray approach to its treatment in this Manual (based on geometrical optics). We discuss relevant parameters and their use in a measurement equation as a systematic technique for analyzing measurement problems. We also present the system of units and nomenclature used herein.

OPTICAL RADIATION. Energy propagated in the form of electromagnetic waves or particles (photons), which can be reflected, imaged, or dispersed by optical elements, such as mirrors, lenses, or prisms, is referred to here as optical radiation. In the spectrum of electromagnetic waves, shown in figure 1.1, optical radiation lies between x-rays and microwaves, i.e., in the interval from about one nanometer to about one millimeter.<sup>1</sup>

---

<sup>1</sup>Commonly used physical units and symbols are listed in Appendix 1.

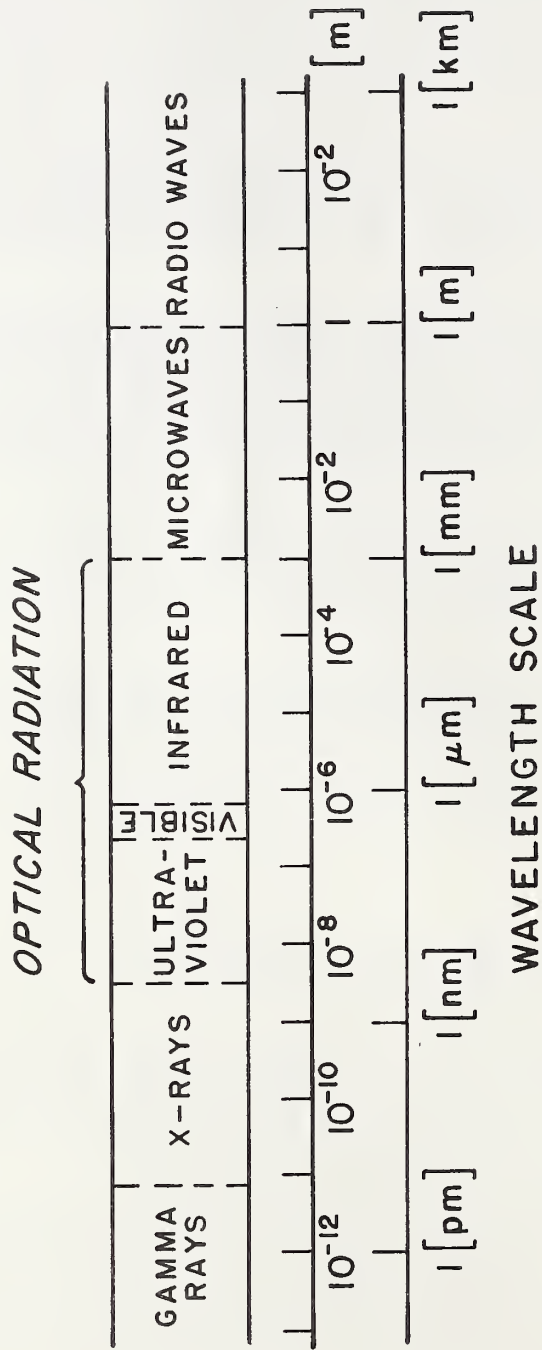

Figure 1.1. Spectrum of electromagnetic waves.

The most familiar portion is visible light, which lies between about 400 and 700 nanometers, the approximate limits of the human-eye response in full daylight. None of these limits is very sharp; only approximate boundaries exist between the wavelength regions of figure 1.1.

Physical theories and models of physical phenomena are abstractions or idealizations that approximate, more or less, what actually takes place in the "real" world. For example, Newton's laws of motion are quite adequate for dealing with most ordinary mechanical devices of everyday experience. But in cases involving atomic particles or astronomical bodies moving at very high velocities, the more sophisticated relations of Einstein's theory of relativity are needed. Quite possibly that theory, in turn, will be found to be only approximately true and will need to be supplemented, for certain applications, by still more sophisticated treatments. Similarly, there are three approaches or models for dealing with optical phenomena, each with its region of useful validity. They are: *geometrical* optics (ray optics), *physical* optics (wave optics), and *quantum* optics (particle optics).

The simplest approach to optics, and the one used in this Manual almost exclusively, is that of geometrical optics or ray optics. It accounts very well for the way in which optical radiation is propagated from most common sources, such as incandescent lamps (light bulbs), fluorescent lamps, arcs, discharges, light-emitting diodes (LED's), and laboratory blackbodies. However, geometrical or ray optics can't account for the patterns (diffraction or interference) which are produced at the edges of certain shadows, in focal regions where rays sharply converge, or by devices called interferometers. Then we require the treatment of what is usually called physical optics or wave optics. Finally, when we deal with interactions with matter in microscopic detail, it is necessary to recognize that energy exchanges take place in discrete amounts. Then we find it useful to consider optical radiation as being propagated in discrete "packets" or photons, whose distribution in large numbers produces average energy distributions in time and space corresponding to the waves of physical optics. For our purposes, it is adequate to treat "classical" optical radiation measurements or radiometry in terms of geometrical optics, with occasional recognition of wave-optics or quantum-optics phenomena as perturbations of the ray-optics relations. Both geometrical and physical optics are based on the wave theory of light, although they can also be reconciled with corpuscular theories. The distinction between them involves mainly the phenomenon of *coherence*.

Electromagnetic waves consist of periodic variations in interrelated electric and magnetic fields, variations that are periodic in space along the direction of propagation and in time at any single point along the path. Emission of electromagnetic radiation can be considered as involving oscillations of individual charged particles in the atoms or molecules of the material of the radiation source. If these are random oscillations, such as those produced by thermal excitation in heated matter, the resulting waves will be similarly random in phase. Then they will combine and propagate as *incoherent* radiation that obeys the laws of geometrical optics, where waves passing through the same point in different directions seem to be completely independent of each other and do not interfere.

However, if the particles are somehow made to oscillate together, "in step" with each other, the resulting waves will be *coherent*. They will have consistent phase relations so that they reinforce or cancel each other over many periods of oscillation, producing the interference patterns that deviate from the laws of geometrical optics. The relations based on geometrical optics do not apply, in many instances, to strongly coherent radiation such as that produced by lasers. However, as previously stated, we can use geometrical optics almost entirely in connection with measurements of common sources, such as those listed, treating the wave- and quantum-optics phenomena as occasional perturbations.

This Manual will deal principally with incoherent optical radiation from about 200 nanometers to about 20 micrometers. We will exclude, at least initially, all laser radiation (see Preface) and the vacuum ultraviolet and far infrared spectral regions. For brevity, we'll refer to this reduced region of incoherent radiation as just "optical radiation."

The MEASUREMENT EQUATION. Every measurement of optical radiation involves a beam of radiation originating at a source, propagating along an optical path, and impinging upon a radiometric instrument. The source may emit radiation or it may be an irradiated object that reflects or scatters radiation incident upon it from another source. The propagation path may traverse a vacuum, or it may pass through a number of different media and involve a variety of interactions with matter, such as reflection, refraction, scattering, absorption, and even emission (by fluorescence). Finally, the radiometric instrument can take many forms, e.g., a bare photocell or a sophisticated spectroradiometer. Two measurement configurations illustrating different combinations of some of these possibilities are shown in figures 1.2 and 1.3. They are not intended for detailed comprehension at this point but only to emphasize the wide range of complexity that can be encountered. We can cope with such complexity only through an orderly, systematic approach, and our approach is based on a measurement equation.

The measurement equation is the mathematical expression that quantitatively relates the output of a measuring instrument to the radiometric quantity that is being measured, taking into account all of the pertinent factors contributing to the measurement result. The main part of that measurement equation relates the radiation input at the receiving aperture of the instrument to the resulting output in terms of the instrument responsivity (output "signal" per unit incident radiation input). The complete equation also accounts, as needed, for the effects of interactions between matter and radiation at the source and along the optical path of the radiation beam as well as at the instrument. Setting all of this down systematically in a quantitative equation helps to insure that all pertinent factors will be appropriately considered and will not be inadvertently overlooked. It also facilitates the evaluation or estimation of the effects of individual parameters by the investigator in order to achieve needed simplifications. The complete equation is usually unmanageably complex until simplifying data or assumptions are introduced to make it tractable. Fortunately, the effects of a number of parameters or variables will often be negligible; the effects of others will be small and easily evaluated. The basic problem is to identify and accurately assess the effects of all significant factors, making



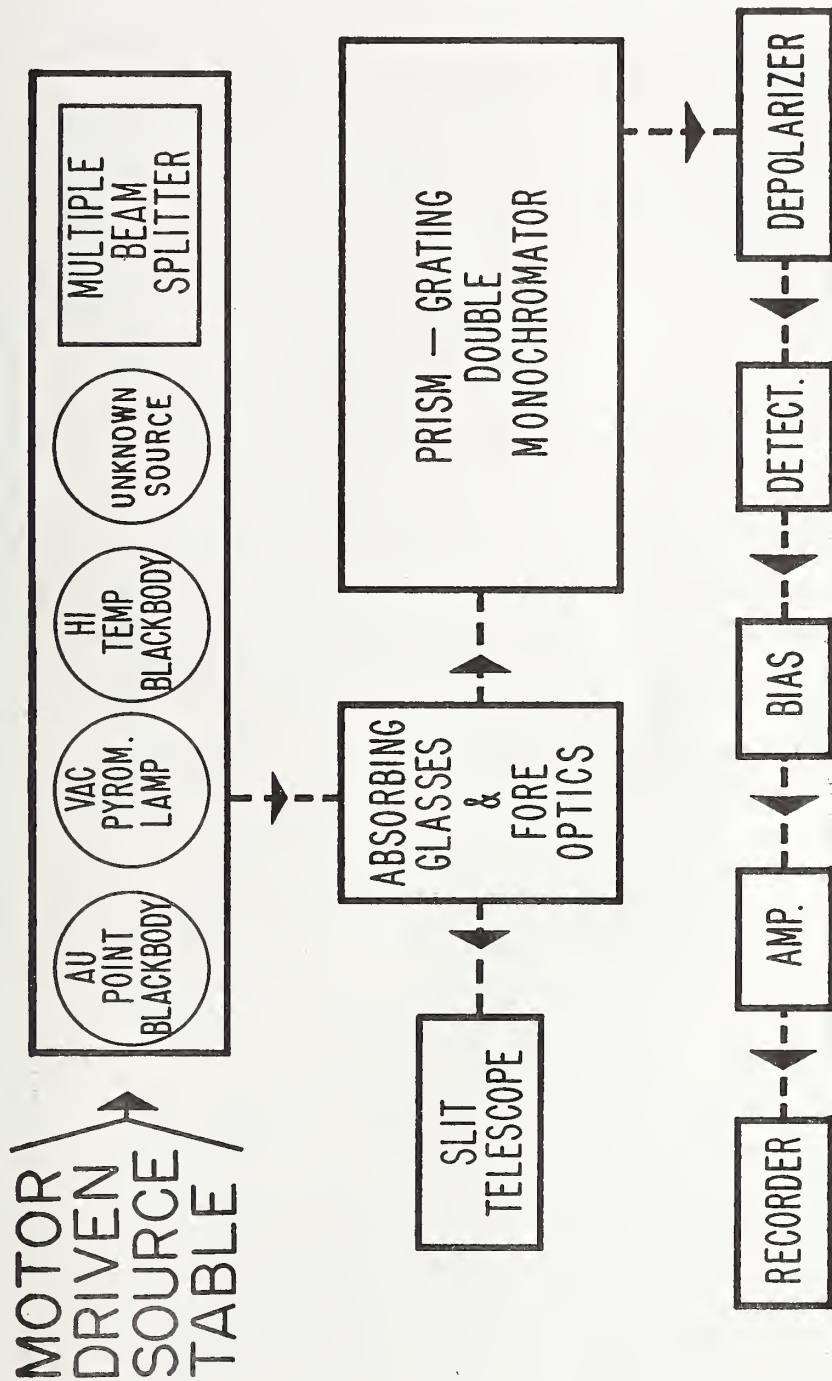

Figure 1.2. A sophisticated spectroradiometer configuration for precision laboratory measurements of spectral radiance.

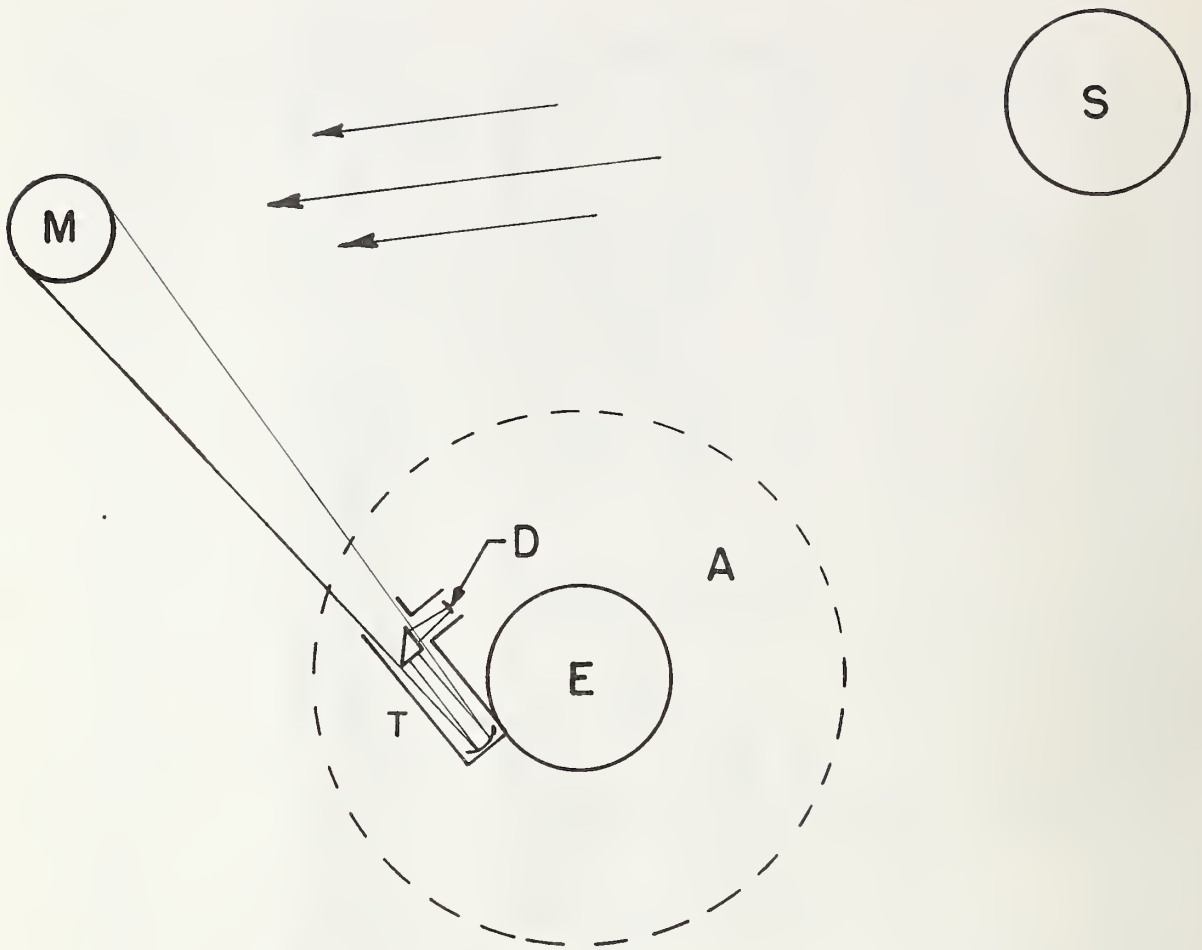

Figure 1.3. Lunar radiation measurement configuration.

The moon M is imaged on a photocell detector D by astronomical telescope T at surface of earth E. The moon shines by reflection of radiation from sun S. The propagation path from M to D includes the earth's atmosphere A and the optics of T. Proportions greatly distorted to bring out significant details.

simplifications wherever possible in order to obtain tractable expressions. The measurement equation provides a mechanism for approaching this systematically, thereby minimizing the chance that any significant factor will be inadvertently overlooked.

The quantities used in the measurement equation are expressed in terms of the radiation parameters and pertinent instrumental and environmental parameters. The distribution of radiant power (radiant energy flow) or flux in a beam of incoherent optical radiation is completely described or specified in terms of five radiation parameters: position, direction, wavelength, time, and polarization. The measurement of optical radiation is a multi-dimensional problem that always involves these five variables and, possibly, others as well. The strength of radiation can be different at different points in space, in different directions from any one point, for different wavelengths, and for different polarizations, and it can vary greatly with time. In addition, the interactions between radiation and matter -- absorption, emission, scattering or reflection, and refraction -- may also depend upon these same five radiation parameters. Instrumental and environmental parameters may also affect a measurement (e.g., temperature, humidity, magnetic fields). Although they can't be so conveniently and exhaustively listed, we'll try to provide systematic approaches for identifying and dealing with all those of significance in a wide variety of situations, particularly when we reach Part III, Applications (see Preface).

UNITS and NOMENCLATURE, A mechanical engineer, concerned with dissipating frictional heat, wants to know how much energy flows away from an exposed hot surface as optical (heat) radiation. He is concerned with the rate of energy flow -- the power -- in the radiation beam, usually expressed in watts. An atomic physicist, concerned with the light emitted by individual particle interactions, wants to know the number of photons flowing in a beam, the number of quanta per second. An illumination engineer, trying to provide adequate lighting on a desk for comfortable and efficient reading and writing, measures light in terms of its effect upon the average human eye, using lumens<sup>1</sup> for units. Thus, there are different ways of stating the amount of optical radiation determined by a measurement; we can use different units of flux, the general term for the quantity of radiation per unit time flowing in a beam.

This Manual will be mainly concerned with radiant power measured in watts. Lumens and related units are used when discussing photometry, and photon flux is utilized when we are concerned with the quantum aspects of interactions between radiation and matter. It cannot be too strongly emphasized, however, that everything said here about the fundamentals of radiometry, even though stated in terms of watts, applies equally to *all* forms of optical radiation measurements. For example, the measurement of illumination for application to vision needs involves all of the fundamentals, not just those discussed in the chapter on photometry. And, conversely, there is much that is pertinent to, say, military applications of infrared radiation in that chapter on photometry. After all, photometry is just the measurement of optical radiation with detectors having a specified spectral

---

<sup>1</sup>The lumen is defined and discussed in a later chapter on "Photometry."

responsivity that is related to that of the human eye. Accordingly, the problems of photometry are, many of them, equally pertinent to measurements with other spectrally-selective sensors, many of which are used extensively in the infrared. Also, many military infrared devices, e.g., night-vision devices, have visual displays where the photometric considerations, as such, are directly applicable. It's all optical radiation in spite of differences in terminology and units.

As a matter of fact, the great diversity of nomenclature that has grown from the use of optical radiation measurements in so many different fields of application is a perennial problem. Different terms are used for the same concept and, conversely, the same term is often used for different concepts. We will employ, as much as possible, the nomenclature of the CIE International Lighting Vocabulary [5]<sup>1</sup> as the most comprehensive and least controversial authority available. Exceptions will be clearly noted when we do depart from or add to the CIE nomenclature at times when we find it inadequate. We will also mention alternative terms and practices that are widely used in the literature where, at least for a long time to come, complete standardization in so many different areas of application just isn't going to take place. For example, it will be a long time, if ever, before astronomers stop using star magnitudes.<sup>2</sup> Accordingly, others who need to use published star radiation data must learn to convert them to the equivalent values of point brilliance or of illuminance or irradiance.<sup>3</sup>

One of the most useful techniques for coping with this unavoidable diversity of nomenclature is the regular use of unit-dimensions and routine unit-dimension-consistency checks for all radiometric quantities and their mathematical relationships [6]. This Manual will follow the practice of associating the proper units and their dimensions with each physical quantity that enters into an important equation. This will facilitate verification of the consistency of the unit-dimensions of the final result. All unit symbols are enclosed in square brackets to emphasize their dimensionality in this connection. Standard SI units and symbols are used wherever possible and exceptions are noted.<sup>3</sup>

SUMMARY of CHAPTER 1. Optical radiation is defined as energy propagated as electromagnetic waves or photons which can be manipulated and studied by optical elements (e.g., mirrors and prisms). This Manual treats incoherent optical radiation in the wavelength region between approximately 200 nanometers and 20 micrometers. The method of treatment employs geometrical optics or ray optics.

Incoherent optical radiation is completely specified in terms of the five radiation parameters: position, direction, wavelength, time, and polarization. Its interaction with matter, as it traverses an optical path and is directed and measured by an instrument, is also governed by these radiation parameters, as well as by environmental and instrumental

---

<sup>1</sup>Figures in brackets indicate literature references listed at the end of the Technical Note.

<sup>2</sup>A star magnitude is a logarithmic unit of incident flux per unit area.

<sup>3</sup>See Appendix 1.

parameters that cannot be exhaustively listed. The quantitative interrelationship between the incident radiation and the measured result in a measurement equation, in terms of all relevant parameters, is the basic approach in this Manual. The complete measurement equation, usually too complex for a complete general solution, facilitates the evaluation of the effects of simplifying data and assumptions used to obtain more tractable expressions for particular applications. It provides a systematic approach that helps to minimize the chance that any significant factor may be inadvertently overlooked.

Radiometric relations are usually given in this Manual in terms of flux in watts, with photometric and photon-flux quantities also employed, when appropriate. Nomenclature follows the CIE system, with exceptions and additions noted and with alternate terms also supplied, if they are widely used. Unit-dimension checks are recommended for dealing with nomenclature confusion and diversity. SI units and symbols are used wherever possible and exceptions are noted.

## Chapter 2. Distribution of Optical Radiation with respect to Position and Direction -- Radiance.

by Fred E. Nicodemus and Henry J. Kostkowski

In this CHAPTER. We introduce the basic radiometric quantity radiance.<sup>1</sup> This quantity allows us to explicitly characterize the distribution of radiant power from point to point and direction to direction throughout a beam of optical radiation. This is particularly important when both the power distribution, and the sensitivity (responsivity) of a radiometer used to measure this power, are non-uniform or non-isotropic. We also show how the total power in the beam can be obtained from the radiance distribution. Finally, we show how to determine the distribution of radiance at any surface, through which the beam passes, in terms of the distribution at any other surface that also intersects the entire beam.

The OPTICAL-RAY APPROACH. In figure 2.1 we see a side view of a lamp with a flat, glowing, tungsten-ribbon filament, and a detector-receiver that is irradiated by the lamp. A ray drawn from a point on the lamp filament to a point on the receiver surface represents the optical radiation originating at a small area element around this point, propagating along the line drawn, and impinging on the receiver area element. Thus a ray is a line or direction along which optical radiation flows. In terms of waves, it is the direction in which that particular part of the light wave is traveling.

From experience, we know that different parts of the glowing tungsten surface will not appear equally bright to the eye. The ends of the ribbon filament are cooler than the rest so point 1 in figure 2.1 will typically be brighter than point 2. Moreover, though to a lesser degree, the brightness of any point, such as point 2, will also change with direction. It will be different when viewed from directions a, b, and c. Thus, the positional and directional distribution of optical radiation can be associated with rays if we can find a way of associating a definite quantity or concentration of radiant power or flux with each ray. This can be done through the quantity called radiance, a concept which we now develop.

---

<sup>1</sup>The purely geometrical aspects of radiance are identical to those of the photometric quantity luminance and are approximately the same as those of the familiar psychophysical quantity brightness. Radiance pertains to flux (amount of radiation flowing) measured in watts or other power units, and luminance to flux measured in lumens, units that are related to standardized eye response (defined and discussed in the chapter on Photometry). Brightness is related to luminance in that incandescent sources of equal luminance usually appear equally bright. However, a common "optical illusion" shows that the apparent brightness of an area can be strongly affected by a background or "surround" of a different brightness. Also, the familiar photographic "gray scales," with steps of apparently equal brightness difference, actually have luminance or radiance steps of approximately equal ratio, i.e., a logarithmic scale of luminance or radiance. Introduction of color makes things even more complicated. A completely satisfactory theory still eludes the experts in colorimetry and vision research.

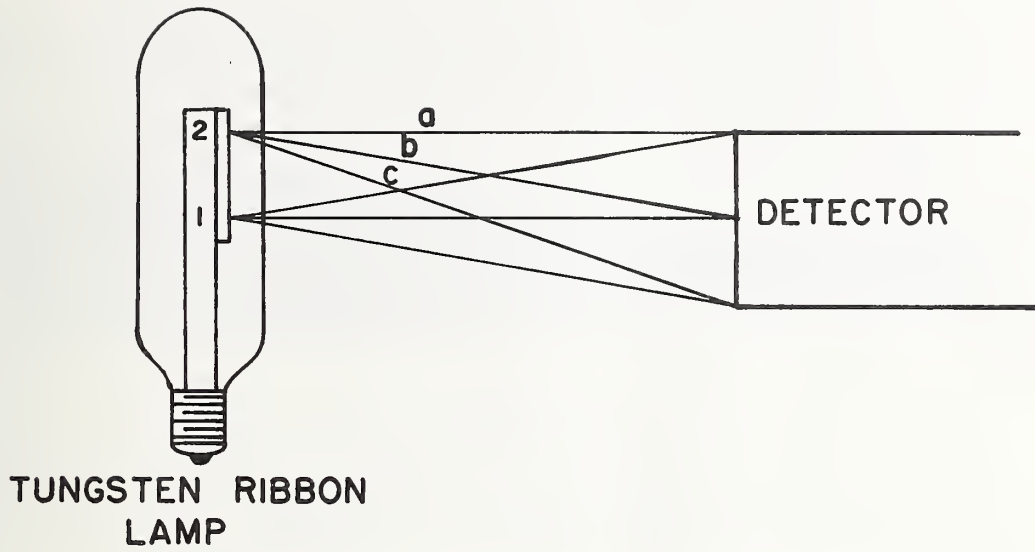

Figure 2.1. Rays from lamp source to detector-receiver.

RADIANCE (through two apertures). Consider an experiment (figure 2.2) with a large-area visible-wavelength source that appears uniformly bright from all directions, two black screens each having a small aperture, and a photocell next to the second screen. The photocell responds to all the radiant power reaching it from the source through both apertures. The beam from source to photocell consists of all rays in the shaded region between the extreme rays through both apertures, as shown in the figure. It is assumed that the medium (air) is perfectly transparent, with a negligible loss of radiant power from the beam by scattering or absorption. If the power  $\Delta\phi$  in the beam is measured for different aperture areas  $\Delta A_1$  and  $\Delta A_2$  (perpendicular to the plane of figure 2.2), and for different distances  $D$  between the apertures, it is found, over a wide range of values, to be proportional to the quantity

$$\frac{\Delta A_1 \cdot \Delta A_2}{D^2} \quad (2.1)$$

The measured power or flux  $\Delta\phi$  also changes when the brightness of the source changes. We denote the radiometric quantity that corresponds to that brightness by the letter  $L$ . Then we can write

$$\Delta\phi = L \cdot \frac{\Delta A_1 \cdot \Delta A_2}{D^2} \quad (2.2)$$

Also, if the apertures aren't kept perpendicular to the central ray through both of them, we find that the measured flux also varies with the cosines of the angles of tilt, shown in figure 2.3. This makes our final expression

$$\Delta\phi = L \cdot \frac{\Delta A_1 \cdot \cos\theta_1 \cdot \Delta A_2 \cdot \cos\theta_2}{D^2} \text{ [W]}^1 \quad (2.3)$$

Next we note that, holding the apertures fixed, the measured flux doesn't change when the source is moved farther away from, or closer to, the apertures or tilted, just as long as all rays in the beam through both apertures come from the uniformly bright emitting surface. Only if we change the source so that it is no longer uniform and isotropic does the measured flux vary with the position and orientation of the source. We can again make the measured flux less sensitive to source position and orientation, at least to small shifts, by making the apertures  $\Delta A_1$  and  $\Delta A_2$  small compared to their separation distance  $D$  and small compared to the distances on the source surface between points of significantly different brightness.

The experiments show that the quantity  $L$  is not only related to the source brightness but also to the small bundle of rays leaving the source in a region of uniform brightness. In fact, it appears to have the same value anywhere along such a bundle of rays. Its value can be obtained for our sample situation by solving eq. (2.3) for  $L$ , thus:

---

<sup>1</sup>[W] denotes unit-dimensions of watts (see Appendix 1).



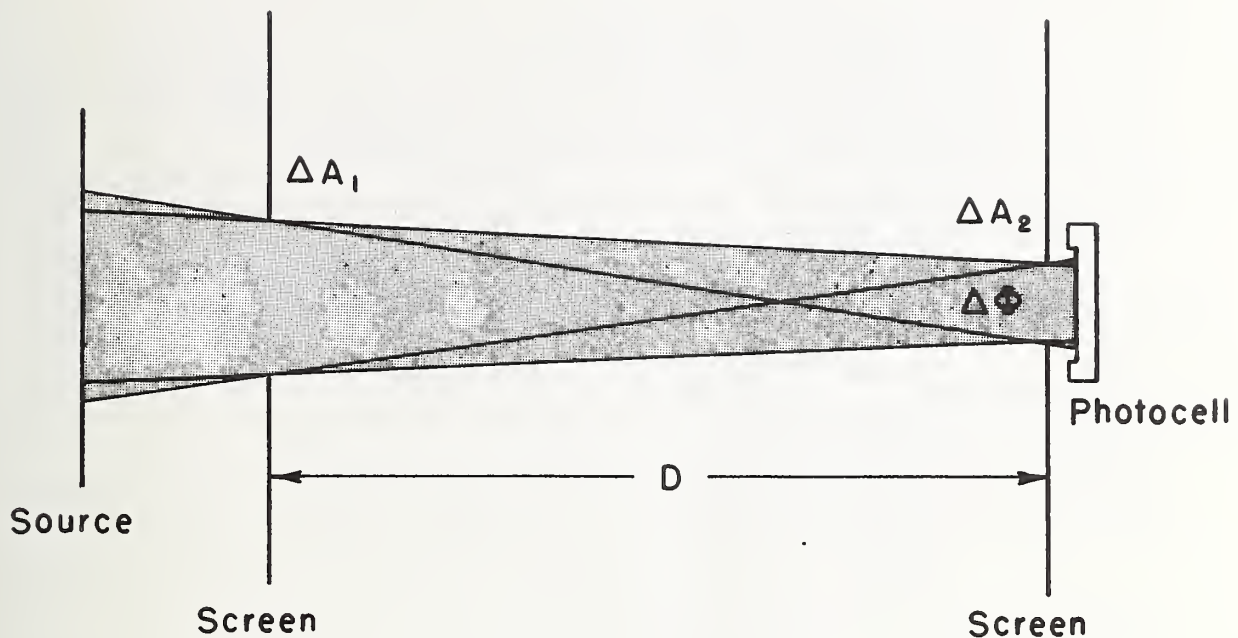

Figure 2.2. Experiment to develop the concept of radiance.

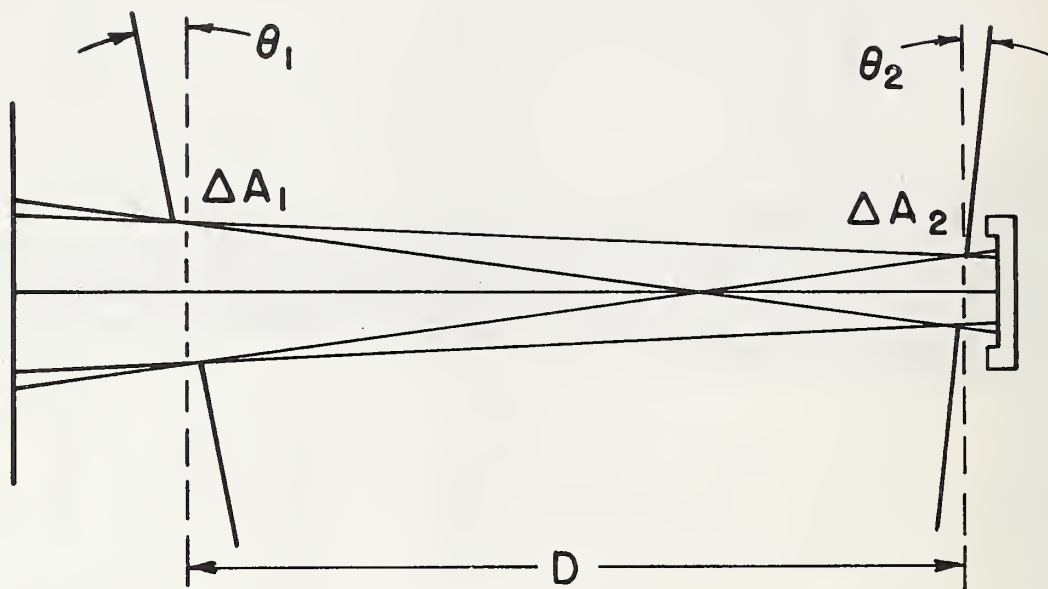

Figure 2.3. Tilted apertures

$$L = \frac{\Delta\phi \cdot D^2}{\Delta A_1 \cdot \cos\theta_1 \cdot \Delta A_2 \cdot \cos\theta_2}. \quad (2.4)$$

Actually, careful measurements, and measurements with sources of more uneven brightness, show that these equations yield only average values of  $L$ . On the other hand, if we try to evaluate  $L$  for a smaller beam, representing just a portion of the larger beam, by making the apertures smaller and the distance  $D$  larger, we reach a point where there is no longer enough power in the beam reaching the photocell to make a measurement at all. Even before that happens, we may encounter diffraction effects where our geometrical-optics model of propagation along rays no longer adequately describes the situation. Nevertheless, if we are careful to observe the limitations of geometrical optics, not applying our equations, without corrections, to situations involving significant diffraction or interference effects, we can obtain relations having a very wide useful range of application by the mathematical-analysis methods of calculus. To do this, we assume an underlying continuous distribution of flux among the rays of the radiation beam, even when the apertures are made arbitrarily small [7].

We define the quantity  $L$ , then, as the limit of the quotient of flux  $\Delta\phi$ , passing through both  $\Delta A_1$  and  $\Delta A_2$ , by the geometrical quantity  $(\Delta A_1 \cdot \cos\theta_1 \cdot \Delta A_2 \cdot \cos\theta_2)/D^2$  as  $\Delta A_1$  and  $\Delta A_2$  are made smaller and smaller. This is written

$$L = \lim_{\substack{\Delta A_1 \rightarrow 0 \\ \Delta A_2 \rightarrow 0}} \frac{\Delta\phi}{(\Delta A_1 \cdot \cos\theta_1 \cdot \Delta A_2 \cdot \cos\theta_2)/D^2}. \quad (2.5)$$

But this is just the defining equation for a second derivative, so that

$$L = \frac{d^2\phi}{dA_1 \cdot dA_2 \cdot \frac{\cos\theta_1 \cdot \cos\theta_2}{D^2}}. \quad (2.6)$$

In the limit, as the apertures become vanishingly small, there remains only a single ray through both of them, so radiance, so defined, is associated with an elementary beam collapsed to just a single ray. This doesn't mean however, that it's ever possible to actually measure the radiance of just a single ray. Real measurements always involve apertures and beams of finite dimensions, as in eq. (2.4), which then yield only average values of radiance. Such an average value equals the actual radiance only when the beam is completely uniform and isotropic with all rays having exactly the same value of radiance.

There is now no limit to how large the apertures may be. By using integral calculus, we can relate the ray-radiance distribution to the total flux or power flowing in a beam of any size. We begin by imagining that each large aperture is divided into many small areas, each small enough so that, through any pair of these small areas (one in each aperture), all rays have the same radiance. The flux through each such pair of small areas can be

calculated by eq. (2.3) and the results added up, for all such pairs to account for the full area of each aperture, to obtain the total flux in the entire beam. A simple example of just three small areas in one aperture and four in the other is illustrated in figure 2.4. Then if, for example, the flux in the portion of the beam between area 2 of the first aperture and area 3 of the second aperture is designated as  $\Delta\phi_{23}$ , we can write the expression for the total flux in the beam through both apertures as

$$\begin{aligned} \Phi = & \Delta\phi_{11} + \Delta\phi_{12} + \Delta\phi_{13} + \Delta\phi_{14} + \\ & \Delta\phi_{21} + \Delta\phi_{22} + \Delta\phi_{23} + \Delta\phi_{24} + \\ & \Delta\phi_{31} + \Delta\phi_{32} + \Delta\phi_{33} + \Delta\phi_{34}. \end{aligned} \quad (2.7)$$

The flux in the beam through each pair, in turn, is evaluated by eq. (2.3). This is illustrated for the pair  $\Delta A_1$  in the first aperture and  $\Delta A_4$  in the second aperture, in figure 2.5 and the following expression:

$$\Delta\phi_{14} = L_{14} \cdot \frac{\Delta A_1 \cdot \cos\theta_{14} \cdot \Delta A_4 \cdot \cos\theta_{41}}{D_{14}^2}. \quad (2.8)$$

More generally, if each aperture is divided into an arbitrarily large number of small areas, the first into  $i$  areas and the second into  $j$  areas, the total flux in the beam can then be written as

$$\Phi = \sum_{ij} \Delta\phi_{ij} = \sum_i \sum_j L_{ij} \cdot \frac{\Delta A_i \cdot \cos\theta_{ij} \cdot \Delta A_j \cdot \cos\theta_{ji}}{D_{ij}^2} [W]. \quad (2.9)$$

Again using calculus, we let the areas  $\Delta A_i$  and  $\Delta A_j$  become arbitrarily small so the numbers  $i$  and  $j$  become, at the same time, arbitrarily large. This is written as

$$\Phi = \lim_{\substack{\Delta A_i \rightarrow 0 \\ \Delta A_j \rightarrow 0 \\ i \rightarrow \infty \\ j \rightarrow \infty}} \sum_{ij} \Delta\phi_{ij} [W], \quad (2.10)$$

where  $\sum_{ij} \Delta\phi_{ij}$  can be expanded as in eq. (2.9). This is simply the defining equation for the double integral over the two apertures:

$$\Phi = \int_{A_2} \int_{A_1} L \cdot \frac{\cos\theta_1 \cdot \cos\theta_2}{D^2} \cdot dA_1 \cdot dA_2 [W]. \quad (2.11)$$

In practice, if we know both the radiance  $L$  and the slant distance  $D$  along the ray between the area elements  $dA_1$  and  $dA_2$  as functions of the position coordinates of those elements over the full areas of both apertures, the integral for the flux  $\Phi$  can be evaluated, at least on a computer. Usually, however, we try to make measurements under conditions where the radiance  $L$  is the same, or approximately so, for every ray through both apertures. Then, as a constant, it can come outside the integrals, leaving

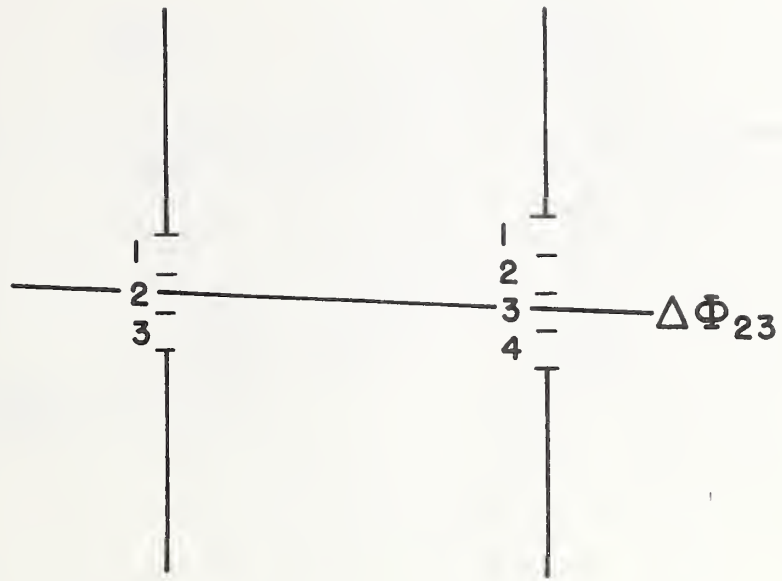

Figure 2.4. Notation for subdivided apertures.

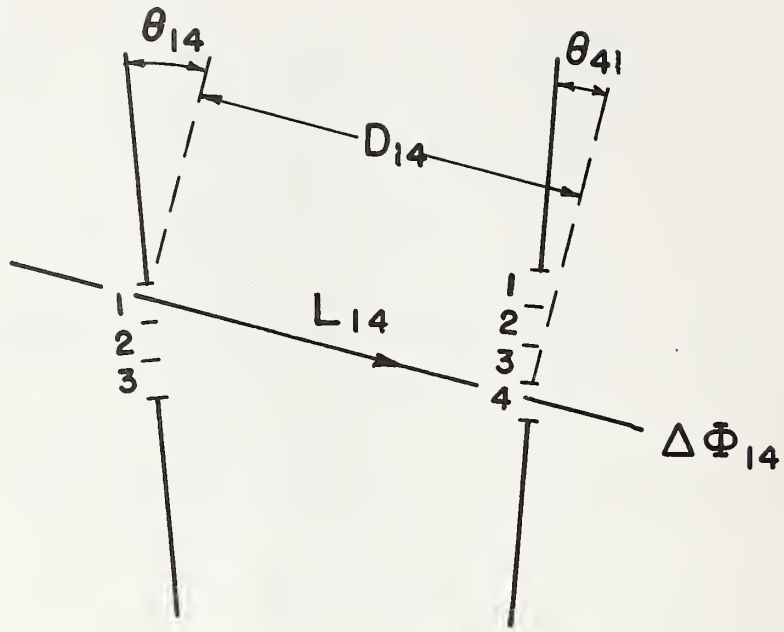

Figure 2.5. Computation of flux  $\Delta\Phi_{14}$ .

$$\phi = L \cdot \int_{A_2} \int_{A_1} \frac{\cos\theta_1 \cdot \cos\theta_2}{D^2} \cdot dA_1 \cdot dA_2 \text{ [W]}. \quad (2.12)$$

Evaluation of these double integrals can become quite complicated. However, integrals of this type have been evaluated and tabulated for many different geometrical configurations, with different sizes, shapes, orientations, and separations of  $A_1$  and  $A_2$ , as we'll see in more detail in Chapter 4 and the accompanying Appendix 3.

RAY RADIANCE (at a point in a direction). The defining equation for radiance, eq. (2.5), can be written in a different way by recognizing that  $(\Delta A_2 \cdot \cos\theta_2)/D^2 = \Delta\omega_{12}$  is the solid angle<sup>1</sup> in steradians [sr] subtended at  $\Delta A_1$  by  $\Delta A_2$ , as shown in figure 2.6. Accordingly, radiance can also be defined as

$$\begin{aligned} L &= \lim_{\substack{\Delta A \rightarrow 0 \\ \Delta\omega \rightarrow 0}} \frac{\Delta\phi}{\Delta A \cdot \cos\theta \cdot \Delta\omega} \\ &= \frac{d^2\phi}{dA \cdot \cos\theta \cdot d\omega} \text{ [W}\cdot\text{m}^{-2}\cdot\text{sr}^{-1}\text{]}. \end{aligned} \quad (2.13)$$

In this form, it is easier to recognize that the units of radiance are watts per square meter and steradian, as shown. This form is also more general, since it defines  $L$  at a point in the direction of a ray through that point, rather than between two points. With this approach we need not assume a perfectly transparent medium with no attenuation between the two points. However, we have presented both approaches because this concept, involving simultaneous variation and distribution of flux in both position and direction, is a difficult one. Many find the first approach easier to understand while others prefer the second approach which, in any event, has definite advantages for many applications.

Radiance is a ray-associated field quantity. What this means is that its value depends on the point in space where it is evaluated and on the ray direction through that point. It is the concentration of propagated optical flux or power, with respect to both position and direction, as a function of both position and direction. We'll define it more explicitly in mathematical terms and use the definition to relate the radiance along an emitted ray at the surface of a source to its value at subsequent points along that ray, particularly at the point of incidence on the surface of a receiver. At the same time, we develop the concept of the element of propagated flux associated with each ray as the product of (1) the radiance and (2) the associated element of throughput, which is also defined. The distribution of these quantities, as functions of position and direction, incident on the receiving aperture of a radiometer or radiometric device can then be combined with the flux responsivity of the instrument, which may also be a function of position and direction of the incident flux element, to obtain the instrument output in terms of the incident radiation input and the spatial parameters. However, we won't take that step until Chapter 4.

The precise, explicit definition of radiance [8] is given first in words and then

<sup>1</sup>See Appendix 2 for definition and discussion of the concept of solid angle.

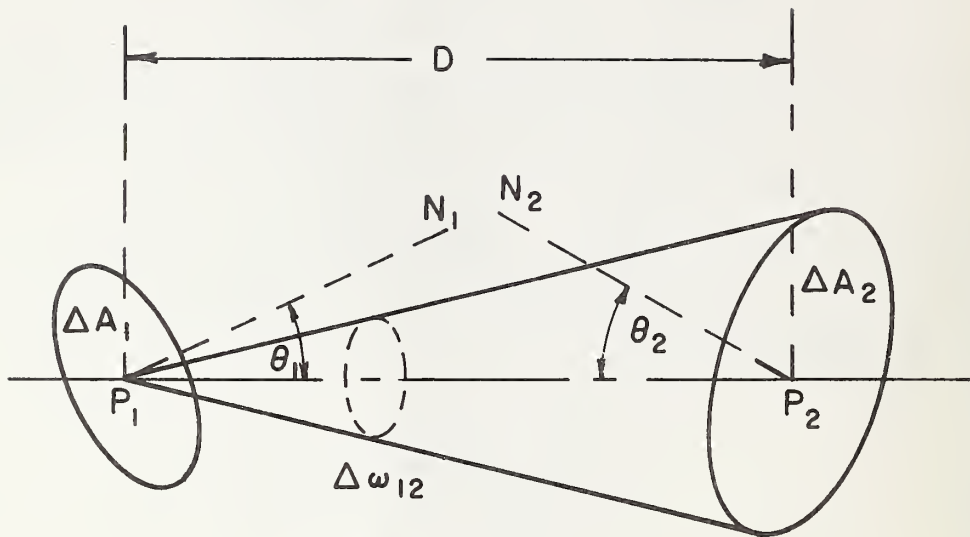

Figure 2.6. The solid angle  $\Delta\omega_{12}$  subtended at  $\Delta A_1$  by  $\Delta A_2$ .

$P_1N_1$  is normal to  $\Delta A_1$

$P_2N_2$  is normal to  $\Delta A_2$



mathematically (refer to figure 2.7). The radiance at a point on a surface in the direction of a ray through that point is defined as the radiant flux or power per unit projected-area-perpendicular-to-the-ray-at-the-point and unit solid-angle-in-the-direction-of-the-ray-at-the-point.

$$L(x,y,\theta,\phi) \equiv \frac{d^2\Phi(x,y,\theta,\phi)}{dA \cdot \cos\theta \cdot d\omega} \quad [W \cdot m^{-2} \cdot sr^{-1}], \quad (2.14)$$

where

$L(x,y,\theta,\phi) [W \cdot m^{-2} \cdot sr^{-1}]$  is the radiance at the point  $x,y$  in the direction  $\theta,\phi$ ;

$x$  and  $y$  [m] are the position coordinates, on the surface, of the point of intersection with the ray (usually, but not necessarily, it is convenient to have a plane reference surface, in which case  $x$  and  $y$  are cartesian coordinates);

$\theta$  and  $\phi$  [rad] are spherical coordinates;<sup>1</sup>  $\theta$  is the polar angle between the ray and the normal (perpendicular) to the surface at the point  $x,y$  and  $\phi$  is the azimuth angle about the point  $x,y$  in the plane tangent to the surface at the point  $x,y$ ;

$d^2\Phi(x,y,\theta,\phi) [W]$  is the element of radiant flux through the surface element  $dA = dx \cdot dy [m^2]$  about the point  $x,y$  and within the element of solid angle<sup>1</sup>  $d\omega = \sin\theta \cdot d\theta \cdot d\phi [sr]$  in the direction  $\theta,\phi$ ; and

$dA \cdot \cos\theta [m^2]$  is the element of projected area perpendicular to the ray direction  $\theta,\phi$ .

As we saw in eq. (2.13), radiance as defined here is the limit, as  $\Delta A$  and  $\Delta\omega$  both approach zero, of the quotient in the first line of that equation, where  $\Delta\Phi$  is the radiant flux or power flowing through the area  $\Delta A$  within the solid angle  $\Delta\omega$ . In order for this quotient to converge (approach a definite limiting value) at the point  $x,y$  in the direction  $\theta,\phi$ , the flux  $\Delta\Phi$  must also become vanishingly small as  $\Delta A$  and  $\Delta\omega$  both approach zero. Thus, as we've already pointed out, we can never exactly measure this quotient at a point and in a given direction; all we can ever measure in reality is its average value over small intervals of area and solid angle through which enough flux can pass to produce a measurable output "signal" in a radiometer. (Of course, if the radiance has the same value throughout a beam, the average value will equal the value along any single ray, so this is the way we try to make the most accurate measurements.) It is very important to understand this limitation clearly; but it certainly doesn't destroy the usefulness of the *concept* of radiance.

Actually, there are many such "point functions" that can't be exactly measured. Some are so familiar as part of our everyday experience that we never stop to think about this

---

<sup>1</sup>Spherical coordinates, solid angles, etc., are discussed in Appendix 2 for those who may wish to refresh their memories on these topics.

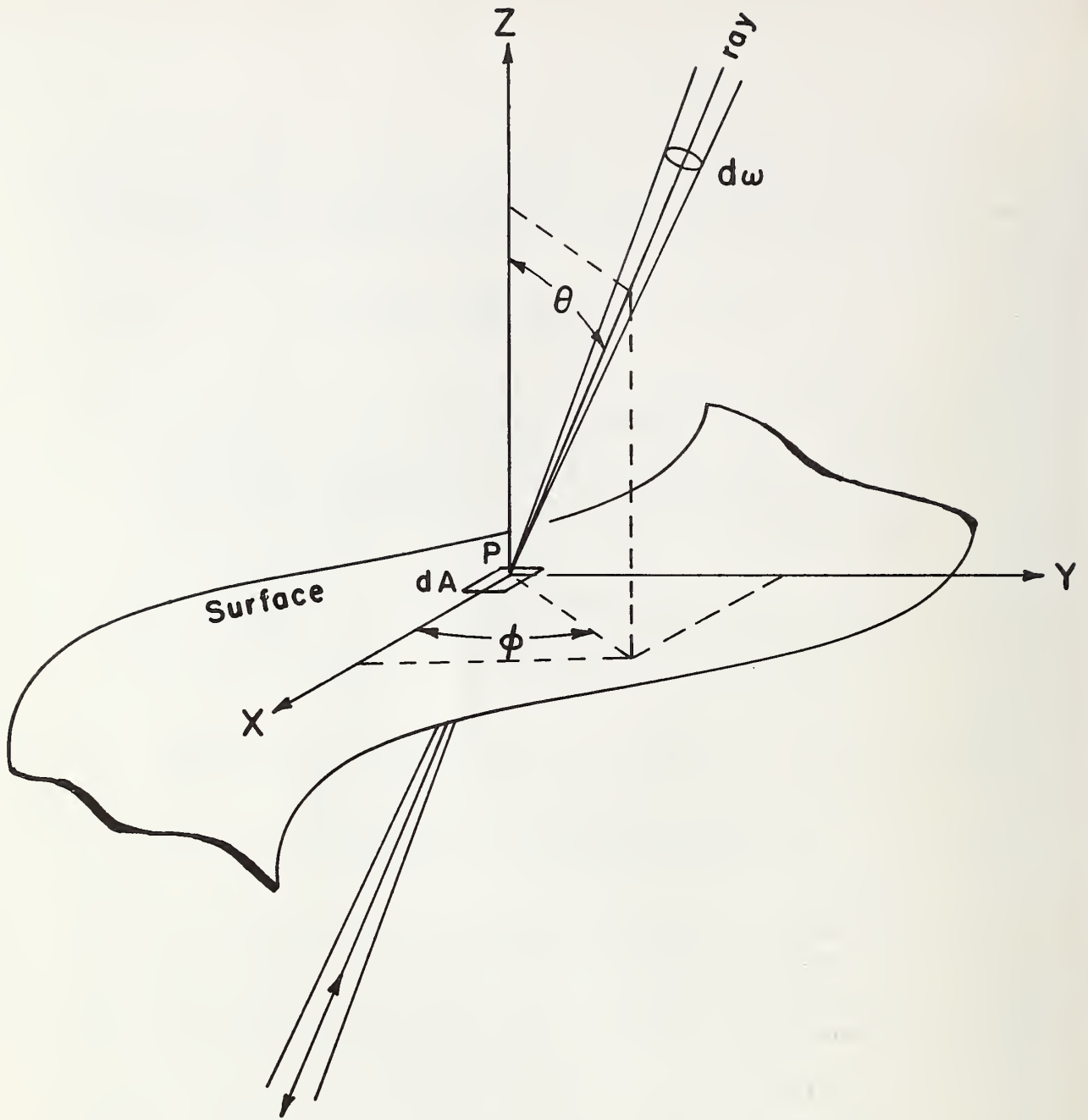

Figure 2.7. Geometry of ray-surface intersection (for the definition of radiance).

limitation. A good example would be the concept of density, i.e., of mass per unit volume. It's obviously impossible to measure density exactly at a point in a region of changing density, as in a flowing gas or liquid where the density varies rapidly from point to point. Nevertheless, most of us have no difficulty with the idea that there is a definite value associated with each point along a path through such a region of (continuously) changing density. But any measurement we make can give us only the average value over a finite volume, not the exact value at a point. In the same way, a radiometer gives an average response to inputs spread over intervals of area and solid angle or intervals of position and direction. But it's still very useful to think in terms of the radiance at a single point and in a single direction through that point as the basis for analysis. Furthermore, as already suggested, we are usually able to detect or indirectly control the uniformity of such a quantity with much greater precision than we can measure its absolute value. Accordingly, by arranging to have the beam for a measurement as uniform and isotropic (constant radiance) as possible, we can make the measured average correspond very closely to the actual value of that constant radiance for all points and directions within the beam.

The ELEMENT of FLUX and the GEOMETRICAL INVARIANCE of RADIANCE. Now let's see how we can use our definition of radiance to express the element of radiant flux associated with a single ray. In figure 2.8 we show first (a) a single ray between two points  $P_1$  and  $P_2$  and second (b) the elementary beam, made up of all the rays between two area elements  $dA_1$  and  $dA_2$  about the points  $P_1$  and  $P_2$ , respectively. As we've seen, an element of area  $dA$  is just a small area  $\Delta A$  that can be made arbitrarily small in the process of approaching a limit, the limiting value of a quotient for a derivative or the limiting value of a summation for an integral. It may be helpful, at first, to think of  $dA_1$  as being part of the emitting surface of a source, such as a tungsten ribbon filament, and, similarly, of  $dA_2$  as being part of the surface of a receiver on which the ray  $P_1P_2$  is incident. However, they can just as well be apertures in real or imaginary screens through which the elementary beam passes. Everything we say now, in the following discussion, is equally applicable to *any* pair of two (imaginary) surface elements intersecting *any* two points  $P_1$  and  $P_2$  along the path of a single ray. These points may be arbitrarily chosen anywhere along the ray.

In figure 2.8(b), we have also drawn the normals  $P_1N_1$  and  $P_2N_2$ , perpendicular to the surface elements  $dA_1$  and  $dA_2$ , respectively. The ray and normal that intersect at  $P_1$  form an angle  $\theta_1$ ;  $\theta_2$  is the angle between the ray and normal intersecting at  $P_2$ . In many cases, when the surfaces of interest are parallel to each other,  $\theta_1 = \theta_2$ . However, we don't want formulas that are too restricted in their application, so we've chosen the more general case where these angles of tilt may (or may not) be unequal. On the other hand, we do want to restrict ourselves, at first, to a medium in which the index of refraction is everywhere the same, that is, where radiation flows at the same velocity everywhere and in all directions (uniform and isotropic), so that all rays are straight lines. Later, we'll see how to deal with the still more general case where the refractive index is found to vary.

The elementary beam of radiation between  $dA_1$  and  $dA_2$ , the beam defined by those two surface elements, consists of all of the rays along which radiation flows or is

(a)



Figure 2.8 (a) A single ray

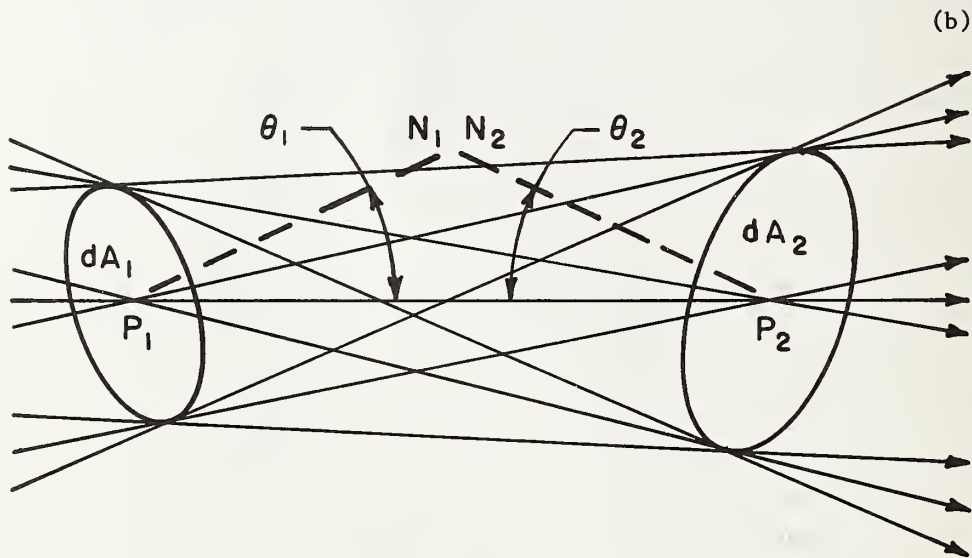

Figure 2.8 (b) An elementary beam of radiation

$P_1N_1$  is normal to  $dA_1$

$P_2N_2$  is normal to  $dA_2$

propagated between the two surface elements. In other words, all of the rays joining points on  $dA_1$  to points on  $dA_2$ , taken as a whole, constitute the beam. If we were to try to draw them all, we'd just have a solid black band that wouldn't show the detail in which we're interested. Instead, we've just suggested what's involved by drawing in these rays for only three points on each surface element, one at  $P_1$  or  $P_2$ , respectively, near the center, and the other two at the edge on opposite sides in each case. Even this ends up as a fairly "busy" figure, with nine rays altogether, three from each point on one surface element to each of the three points on the other surface element.

Rays that all intersect at a common point are said to form a pencil of rays. If we consider the radiation in figure 2.8(b) to be flowing from  $dA_1$  to  $dA_2$ , the diverging rays from any one point on  $dA_1$  to all points on  $dA_2$  form an exitent<sup>1</sup> pencil, while those converging at any one point on  $dA_2$  from all points on  $dA_1$  form an incident pencil. The extreme rays between a point on either area element and the entire edge of the other area element form a cone bounding the solid angle subtended at the point by that area element.<sup>2</sup> The element of solid angle subtended by  $dA_2$  at  $P_1$  is given by  $d\omega_{12} = \cos\theta_2 \cdot dA_2 / D^2$  [sr], where  $D$  [m] is the distance between  $P_1$  and  $P_2$ . Similarly, the element of solid angle subtended at  $P_2$  by  $dA_1$  is given by  $d\omega_{21} = \cos\theta_1 \cdot dA_1 / D^2$  [sr]. When the area elements are small enough, the solid angle subtended by either one of them at a point on the other is the same for all such points.

With these geometrical relations established, we can turn our attention to the flow of radiant energy in the beam of figure 2.8(b). When the area elements are small enough, there will be no significant differences in radiance between the rays through different points across a surface element or in different directions within the pencil of rays to the other surface element through any single point of the first element. Accordingly, we assume that all of the rays leaving  $dA_1$  toward  $dA_2$  are of radiance  $L_1$  and that those same rays all arrive at  $dA_2$  with radiance  $L_2$ . Of course, we've already seen that experiments show that  $L_1 = L_2$ . But we ignore that, for the moment, so that we can also show, by analysis, that  $L_1 = L_2$  follows just from our definition of radiance. We next write expressions for the element of radiant flux or power in the elementary beam through each area element.

If all rays leaving  $dA_1$  are of radiance  $L_1$  watts per square meter of projected area and steradian of solid angle, and they emerge through a projected area (perpendicular to the ray  $P_1P_2$ ) of  $\cos\theta_1 \cdot dA_1$  square meters and within a solid angle of  $d\omega_{12}$  steradians, the flux or power in the exitent elementary beam is the product of these quantities, or

$$\begin{aligned} d\phi_1 &= L_1 \cdot \cos\theta_1 \cdot dA_1 \cdot d\omega_{12} \\ &= L_1 \cdot \cos\theta_1 \cdot \cos\theta_2 \cdot dA_1 \cdot dA_2 / D^2 \text{ [W]}, \end{aligned} \quad (2.15)$$

<sup>1</sup>"Exitent" was coined as an antonym of "incident" by Richmond [9].

<sup>2</sup>Spherical coordinates, solid angles, etc., are discussed in Appendix 2 for those who may wish to refresh their memories on these topics.

which looks very much like eq. (2.3) or eq. (2.8). Similarly, the element of flux or power reaching  $dA_2$  in this same elementary beam is

$$\begin{aligned} d\phi_2 &= L_2 \cdot \cos\theta_2 \cdot dA_2 \cdot d\omega_{21} \\ &= L_2 \cdot \cos\theta_2 \cdot dA_2 \cdot \cos\theta_1 \cdot dA_1 / D^2 \text{ [W]}. \end{aligned} \quad (2.16)$$

If there is no loss of radiant power or flux in the intervening medium, so that all of the flux leaving  $dA_1$  in the elementary beam toward  $dA_2$  arrives at  $dA_2$ , we can set  $d\phi_1 = d\phi_2$ . Then

$$L_1 \cdot \cos\theta_1 \cdot dA_1 \cdot \cos\theta_2 \cdot dA_2 / D^2 = L_2 \cdot \cos\theta_2 \cdot dA_2 \cdot \cos\theta_1 \cdot dA_1 / D^2$$

which reduces to

$$L_1 = L_2. \quad (2.17)$$

Since no restriction was placed on the choice of the points  $P_1$  and  $P_2$  along the ray, eq. (2.17) must apply to *any* pair of points, i.e. to all pairs of points, along that ray. This means that the radiance in the direction of a ray is the same at every point along that ray in the absence of any energy losses or new sources of energy. *Radiance is geometrically invariant along a ray in a passive, lossless, uniform, isotropic medium.* Accordingly, if we know the value of exitent radiance at the surface of a source for a particular ray, this also means that we know its value at any subsequent point of that ray, including the point where it is finally incident on a receiver, providing there are no losses of energy (or new sources of energy) along the intervening path. Moreover, if such losses exist, they can be accounted for by an appropriate factor, the propogance of the path, which we'll define and discuss in detail later.<sup>1</sup>

APPLICATIONS of RADIANCE INVARIANCE. Although we won't get into a thorough discussion of applications until Part III, we want to look at some of the useful applications of the invariance property of radiance now because it will help to clarify the significance of this important quantity. First, however, we need to examine what happens when a ray traverses different media with different refractive indices. Even though the atmosphere is often reasonably uniform and isotropic, especially for measurements in the laboratory, rays frequently pass also through lenses, prisms, or other optical elements with quite different refractive indices. We need to know how this affects the value of radiance along a ray.

Most of the optical elements with which we are concerned have relatively smooth surfaces so we'll analyze the situation for regular (specular) transmission, with refraction, at a smooth boundary surface between two media of different refractive indices, as depicted in figure 2.9. We define a "smooth" surface as any surface where it is possible to construct a tangent plane, i.e. where every surface element  $dA$  can be treated as common to the surface and to a plane tangent to the surface at that point. This figure

<sup>1</sup>See eq. (2.37) (on p. 38.)

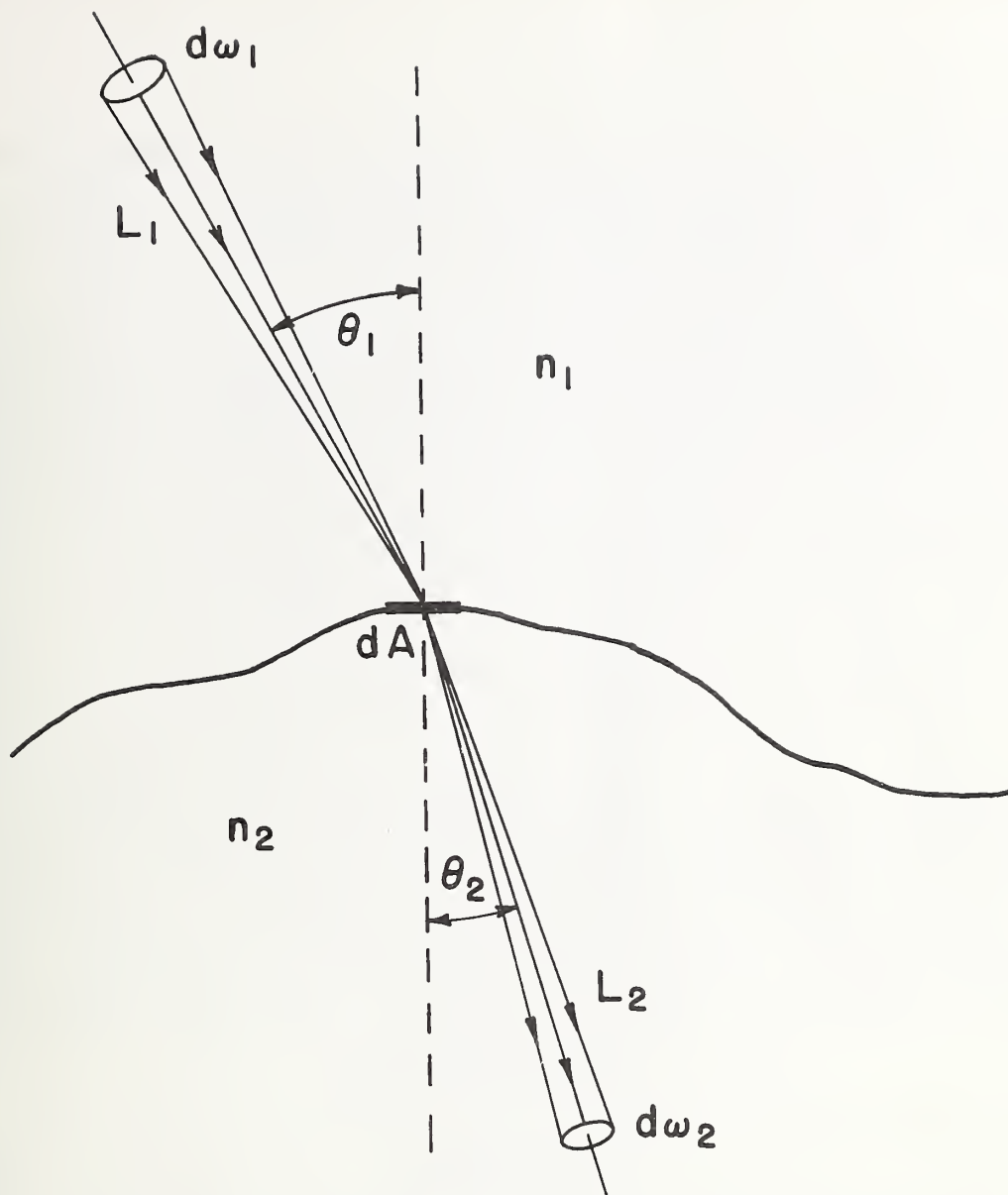

Figure 2.9. Invariance of basic radiance along a refracted ray.

shows a vertical plane (plane of the paper) containing the normal (perpendicular) to a surface element  $dA$  of the smooth surface and an incident ray, inclined at an angle  $\theta_1$  to the normal, within an element of solid angle  $d\omega_1$ , in the medium of refractive index  $n_1$  above the surface. The incident radiance is  $L_1$  [ $\text{W}\cdot\text{m}^{-2}\cdot\text{sr}^{-1}$ ], and the element of radiant flux or power in the elementary beam incident on  $dA$  through  $d\omega_1$  is  $d\phi_1$  [W].

Below the surface, in the second medium of refractive index  $n_2$ , the refracted ray is inclined at an angle  $\theta_2$  and the refracted elementary beam fills an element of solid angle  $d\omega_2$ . This solid-angle element  $d\omega_2$  differs slightly from  $d\omega_1$  because the rays bounding  $d\omega_1$  are refracted by slightly different amounts. The radiance here is  $L_2$  and the element of refracted radiant flux or power is  $d\phi_2$ . As before, we can write the elements of flux in terms of the radiance and the geometrical quantities as

$$\begin{aligned} d\phi_1 &= L_1 \cdot \cos\theta_1 \cdot dA \cdot d\omega_1 = L_1 \cdot dA \cdot \cos\theta_1 \cdot \sin\theta_1 \cdot d\theta_1 \cdot d\phi \quad [\text{W}], \quad \text{and} \\ d\phi_2 &= L_2 \cdot \cos\theta_2 \cdot dA \cdot d\omega_2 = L_2 \cdot dA \cdot \cos\theta_2 \cdot \sin\theta_2 \cdot d\theta_2 \cdot d\phi \quad [\text{W}]. \end{aligned} \quad (2.18)$$

Also, as before, we are interested only in the effects connected with ray and beam geometry so, again, we assume there are no losses in either medium. However, we know that, even with so-called anti-reflection coatings, there will always be some of the incident flux reflected at a smooth surface so that only part of it will be transmitted and refracted. If the total incident element of flux is  $d\phi_1'$  with a radiance  $L_1'$  and the reflected portion is  $\rho \cdot d\phi_1'$  with radiance  $\rho \cdot L_1'$ , then the remainder that is transmitted and refracted without loss is  $d\phi_1 = (1-\rho) \cdot d\phi_1'$  with  $L_1 = (1-\rho) \cdot L_1'$ . Accordingly, setting  $d\phi_1 = d\phi_2$ , since it is transmitted and refracted without loss, we have, from eqs. (2.18),

$$\begin{aligned} \frac{d\phi_1}{d\phi_2} &= \frac{L_1 \cdot dA \cdot \cos\theta_1 \cdot \sin\theta_1 \cdot d\theta_1 \cdot d\phi}{L_2 \cdot dA \cdot \cos\theta_2 \cdot \sin\theta_2 \cdot d\theta_2 \cdot d\phi} = 1 \\ &= \frac{L_1 \cdot \sin\theta_1 \cdot \cos\theta_1 \cdot d\theta_1}{L_2 \cdot \sin\theta_2 \cdot \cos\theta_2 \cdot d\theta_2} \end{aligned} \quad (2.19)$$

a relation involving only radiance and beam geometry and ignoring the portion of the incident flux that is reflected.

The angle of incidence  $\theta_1$  for every incident ray is related to the angle of refraction  $\theta_2$  for the corresponding refracted ray by Snell's law of refraction, which can be stated mathematically as

$$n_1 \cdot \sin\theta_1 = n_2 \cdot \sin\theta_2. \quad (2.20)$$

By differentiating with respect to angle, we also have

$$n_1 \cdot \cos\theta_1 \cdot d\theta_1 = n_2 \cdot \cos\theta_2 \cdot d\theta_2. \quad (2.21)$$

Rearranging eqs. (2.20) and (2.21), we can write

$$\frac{\sin\theta_1}{\sin\theta_2} = \frac{\cos\theta_1 \cdot d\theta_1}{\cos\theta_2 \cdot d\theta_2} = \frac{n_2}{n_1}. \quad (2.22)$$



Finally, combining eqs. (2.19) and (2.22), we have

$$\frac{L_1 \cdot n_2^2}{L_2 \cdot n_1^2} = 1; \quad \text{or} \quad \frac{L_1}{n_1^2} = \frac{L_2}{n_2^2}. \quad (2.23)$$

Accordingly, in going from one medium to another, the invariant quantity is not radiance  $L$ . Instead, it is the basic radiance  $L/n^2$  (where  $n$  is the index of refraction of the medium) that has the same value in the direction of a ray at all points along that ray. In fact, more sophisticated proofs [10] show that the invariance of basic radiance is a completely general geometric property, even along a ray traversing a non-uniform, non-isotropic medium in which the index of refraction varies continuously from point to point. It must be reemphasized that this is a purely geometric property and that the actual radiance or basic radiance is usually further modified by interactions with matter, being attenuated (reduced) by absorption, reflection, or scattering out of the beam, and also possibly augmented (increased) by emission or scattering into the beam. The simplest case of attenuation will be treated briefly at the end of this chapter. More details on such interactions will come later.

For the moment, the important point is that, from eq. (2.23), we can see that radiance  $L$  is geometrically invariant along all parts of the same ray that lie in the same medium (same refractive index), regardless of intervening passage through an optical element (with smooth surfaces) of a different material (different index). The radiance within the material of the optical element changes, keeping the basic radiance constant, but it returns to the original value upon reemerging into the same medium (usually air) again. The only effect, then, is possible attenuation by the optical element, which will be discussed briefly at the end of this chapter and later in more detail.

This is such an important point that it may be helpful to restate it explicitly in mathematical terms. Given a ray of radiance  $L_1$  in a medium of index  $n_1$  that passes through an optical element with smooth surfaces of a material with index  $n_2$  and out into a third medium of index  $n_3$ , the radiance  $L_2$  internal to the optical element and the final radiance  $L_3$  in the third medium satisfy the following (based on eq. (2.23)):

$$L_1/n_1^2 = L_2/n_2^2 = L_3/n_3^2 [W \cdot m^{-2} \cdot sr^{-1}]. \quad (2.23a)$$

Furthermore, if the ray emerges, without attenuation losses, again into the same medium, e.g., into air, so that  $n_3 = n_1$ , this means that  $L_3 = L_1$  and we can ignore the fact that the ray traversed a different medium. As will be shown later, if there are attenuation losses, this will reduce the final value of propagated radiance by the fractional amount of loss.

An EXAMPLE of RADIANCE INVARIANCE. Many photographic exposure meters for measuring reflected light from a scene or object (not the incident light on the object or scene) consist of a photocell mounted behind a baffle, grid, and/or lenses that define the receiving aperture area and solid angle through which rays from the scene or object can

reach the photocell, just as the apertures in the two screens of figure 2.2 define the beam from the source to that photocell. The solid angle of acceptance or field angle of such an exposure meter is typically about  $30^\circ$  to each side or a cone with a total vertex angle of about  $60^\circ$ , roughly the cone subtended by a circular object at a distance equal to its diameter. You can use such a meter to verify the part of the earlier experiment that establishes the invariance of radiance along any ray. Point the meter at a uniformly bright wall from a distance that is clearly less than the height or width of the wall, whichever is the smaller. Note that, over fairly wide limits, the "reading" of the meter doesn't change as you move it in or out or tilt it to "view" different parts of the wall. Only when you get so close that you shade part of the wall in the field of view, or so far away or tilted so far that some of the radiation from the surroundings beyond the uniform wall reaches the photocell, do you see any change. Accordingly, since the rearrangement or substitution of rays within the field of view makes no difference, they must all be of the same radiance as they reach the instrument, regardless of distance or angle, as long as they originate from the uniformly bright wall surface.

The invariance of radiance along a ray enables us to immediately write down a very general rule that is often obtained through a fairly involved mathematical derivation. The rule is that the flux per unit area reaching a point (e.g., on the surface of a receiver) from a distant extended (source) surface of uniform, isotropic (constant) radiance depends only on the value of that radiance and on the solid angle subtended by the (source) surface at that point, the solid angle enclosed by the rays from the extremities of the surface as "seen" from the point. It is otherwise completely independent of the geometrical configuration. For example, in figure 2.10 the heavy lines at A, B, and C, represent three possible configurations for such an extended source with, in each case, the same uniform, isotropic (constant) radiance. It is clear from the figure that, since radiance is invariant along every ray, the configuration of incident ray radiance converging at P will be exactly the same, and so will produce the same flux per unit area, regardless of which of the three sources, A, B, or C, is present, as long as that surface has the same radiance  $L$  [ $\text{W}\cdot\text{m}^{-2}\cdot\text{sr}^{-1}$ ].

GEOMETRICAL INVARIANCE of THROUGHPUT. Although radiance is the complete distribution function describing or specifying the spatial distribution of optical radiation in both position and direction, the physical quantity that flows in a beam of optical radiation is energy, and the flux is the energy-per-unit-time or power flowing, e.g., through some reference surface that intersects the beam. It is to energy or power that radiation detectors usually respond. We said earlier that we need to be able to associate an amount or concentration of propagated flux or power with a ray. Actually, we've already done this in the expressions for the elements of flux or power  $d\phi$  [W] in eqs. (2.15), (2.16), and (2.18). However, we want to go back for another look to get a clearer idea of this quantity and its significance.

From our defining equation for radiance, eq. (2.14), we can directly write the expression for the element of flux  $d\phi(x,y,\theta,\phi)$  along a ray of radiance  $L(x,y,\theta,\phi)$

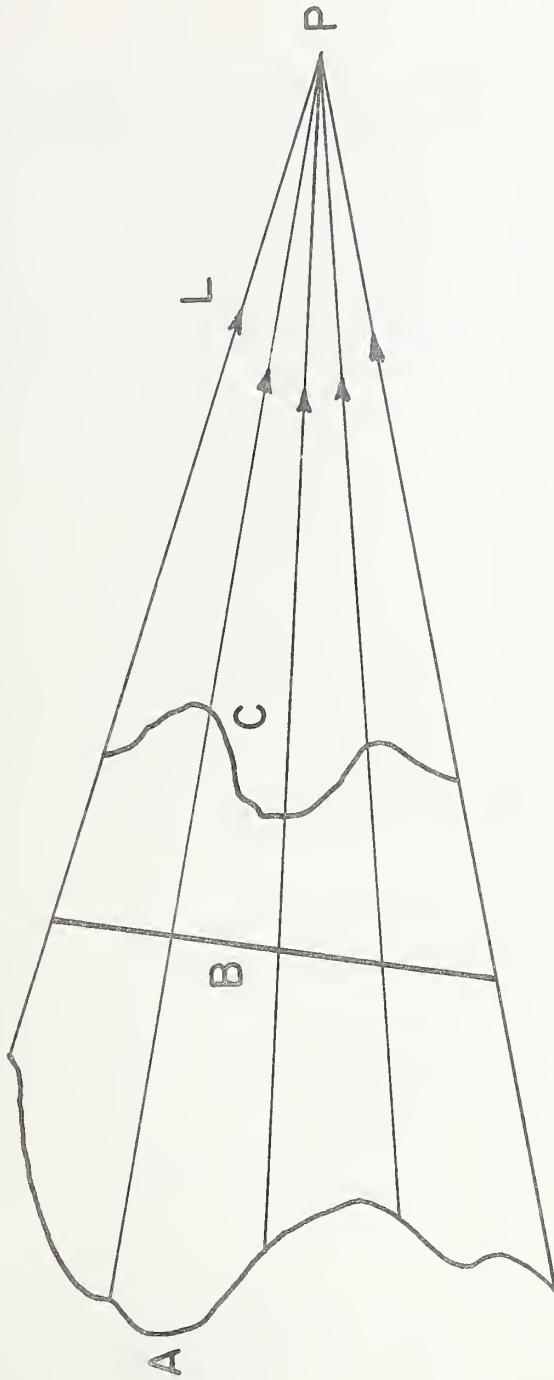

Figure 2.10. Sources A, B, or C, all of the same (uniform, isotropic) radiance L, are indistinguishable when "viewed" from P (only one present at a time).

through an element of surface  $dA = dx \cdot dy$  at its point of intersection  $x, y$  with the ray and within an element of solid angle  $d\omega = \sin\theta \cdot d\theta \cdot d\phi$  about the ray in the direction  $\theta, \phi$ , as<sup>1</sup>

$$d\phi(x, y, \theta, \phi) = L(x, y, \theta, \phi) \cdot \cos\theta \cdot d\omega \cdot dA \text{ [W]}. \quad (2.24)$$

Furthermore, if we know the distribution of radiance  $L(x, y, \theta, \phi)$  across any reference surface over an area  $A$  that includes all points of intersection  $x, y$  between rays of a given beam and that reference surface, and over a solid angle  $\omega$  at each point  $x, y$ , that contains all directions  $\theta, \phi$  for rays of the beam that pass through that point, then by summing up all elements of flux  $d\phi$  we can obtain the total flux  $\phi$  in the beam. This can be done by using integral calculus where

$$\phi = \int_A \int_{\omega} L(x, y, \theta, \phi) \cdot \cos\theta \cdot d\omega \cdot dA \text{ [W]}.^2 \quad (2.25)$$

Note that this is just eq. (2.11) in slightly different form.

In a uniform, isotropic beam, where the radiance has the same constant value  $L$  for all rays of the beam, as with eq. (2.12), this simplifies to

$$\phi = L \cdot \int_A \int_{\omega} \cos\theta \cdot d\omega \cdot dA = L \cdot \Theta \text{ [W]}, \quad (2.26)$$

where

$$\Theta \equiv \int_A \int_{\omega} \cos\theta \cdot d\omega \cdot dA \text{ [m}^2 \cdot \text{sr]} \quad (2.27)$$

is the throughput of the beam [11].

It is clear from eq. (2.27) that the element of throughput is

$$d\Theta \equiv \cos\theta \cdot d\omega \cdot dA \text{ [m}^2 \cdot \text{sr]}. \quad (2.28)$$

Consequently, the element of flux, given in eq. (2.24), can be written simply as

$$d\phi = L \cdot d\Theta \text{ [W]}. \quad (2.29)$$

It is the product of the radiance of a ray and the associated element of throughput.

In a lossless, uniform, isotropic medium, flux or power is conserved and  $d\phi$  remains

<sup>1</sup>Some would prefer that the left side of eq. (2.24) be shown as a second-order differential  $d^2\phi$ , but this raises mathematical questions that we don't want to get involved with. In any event, the order of the differential is somewhat arbitrary, since  $d\phi = L \cdot d\Theta = L \cdot dA \cdot d\Omega = L \cdot dx \cdot dy \cdot \cos\theta \cdot d\omega = L \cdot dx \cdot dy \cdot \cos\theta \cdot \sin\theta \cdot d\theta \cdot d\phi$ .

<sup>2</sup>This is expanded as  $\phi = \int_y \int_x \int_{\phi} \int_{\theta} L(x, y, \theta, \phi) \cdot \cos\theta \cdot \sin\theta \cdot d\theta \cdot d\phi \cdot dx \cdot dy \text{ [W]}$ . (see also Appendix 2).

unchanged along an elementary beam (associated with a ray). We equated  $d\phi_1$  of eq. (2.15) and  $d\phi_2$  of eq. (2.16) when the points  $P_1$  and  $P_2$  of figure 2.8(b) were arbitrarily chosen as any two points along the same ray in such a medium. We then found, in eq. (2.17), that radiance  $L$  is invariant along such a ray. Consequently, if both  $d\phi$  and  $L$  are invariant along a ray and they satisfy eq. (2.29), then the element of throughput  $d\theta$  must also be similarly invariant along the elementary beam associated with that ray. Furthermore, since ray geometry is not altered in any way by attenuation of the flux propagated along those rays, the fact that  $d\theta$  is invariant along a ray in a lossless medium with no attenuation means that it must always be so, even in the presence of attenuation.<sup>1</sup>

If  $d\theta$  is thus invariant along every elementary beam or ray that makes up a given beam of radiation, then its integral for the throughput of the entire beam in eq. (2.27) must be similarly invariant. What this means is that, at any reference surface that intersects the entire beam, the integral of eq. (2.27) will have the same value as long as no rays have been added to or taken away from the beam--as long as it is still made up of exactly the same rays. Thus throughput, a purely geometrical quantity, is the geometrical invariant characterizing any given beam of optical radiation. The larger the throughput the larger the flux propagated through an optical system. In fact, when the radiance is everywhere the same throughout the beam, eq. (2.27) shows that the propagated flux is directly proportional to the throughput. Accordingly, the throughput has been found useful as a figure of merit in making comparisons between different optical systems on the basis of their ability to propagate or transmit radiant flux or power [12].

Another aspect of the geometrical invariance of throughput is seen more readily if we further simplify eq. (2.27) by assuming that the solid angle  $\omega$  filled by rays of the beam is exactly the same at every point  $x,y$ , where rays of the beam intersect the reference surface, over the entire area  $A$ . In other words, there is no vignetting.<sup>2</sup> Then the two integrals comprising the double integral on the right-hand side of the equation are independent of each other, making them separable, so that we can write

$$\theta = \left( \int_A dA \right) \cdot \left( \int_{\omega} \cos\theta \cdot d\omega \right) = A \cdot \Omega \text{ [m}^2 \cdot \text{sr]}, \quad (2.30)$$

where

$$\Omega \equiv \int_{\omega} \cos\theta \cdot d\omega \text{ [sr]} \quad (2.31)$$

is called a projected solid angle (or, sometimes, a weighted solid angle; for more discussion, see Appendix 2). Here the throughput is exactly equal to the product of the area  $A$

<sup>1</sup>As a purely geometrical property, it is possible to establish the invariance of throughput, independently of the invariance of radiance, by purely geometrical reasoning. However, the logic used here is quite correct and a great deal simpler.

<sup>2</sup>See any standard text on geometrical optics [14,15] for definitions and discussions of apertures, beams, stops, vignetting, etc.

of intersection between the beam and the reference surface and the projected solid angle  $\Omega$  corresponding to (and, for small solid angles, approximately equal to) the solid angle  $\omega$  filled by the rays of the beam at its intersection with the reference surface. And even when there is vignetting and the solid angle  $\omega$  varies with position at different intersection points  $x, y$  across the area  $A$ , it is still true that each element of throughput  $d\theta$  can be written as the product of the area element  $dA$  and the element of projected solid angle  $d\Omega \equiv \cos\theta \cdot d\omega$ :

$$d\theta \equiv dA \cdot \cos\theta \cdot d\omega \equiv dA \cdot d\Omega \text{ [m}^2 \cdot \text{sr)].} \quad (2.32)$$

In fact, Jones [13] has proposed the term "area-solid-angle product" for the quantity we call throughput.

The foregoing is not just an exercise in terminology and notation. What eqs. (2.30) and (2.32) tell us is that, since throughput is invariant for a given beam and is also roughly equal to the product of cross-sectional area and solid angle filled by the beam at its intersection with a reference surface, if the area is reduced at the intersection with another reference surface, the solid angle must be correspondingly increased to keep the throughput the same, and vice versa. For example, as illustrated in figure 2.11, the solid angle  $\omega_S$ , subtended at the slide in a slide projector by the projection optics  $O$  is much larger than the solid angle  $\omega_I$  subtended by those same optics at the distant projection screen. If the area of the slide is  $A_S$ , and that of the projected image is  $A_I$ , the approximate relationships are given by

$$\theta \approx A_S \cdot \Omega_S \approx A_I \cdot \Omega_I \text{ [m}^2 \cdot \text{sr)],} \quad (2.33)$$

where the projected solid angle  $\Omega \equiv \int \cos\theta \cdot d\omega \approx \omega$  [sr]. Rays leave each point of the small-area slide surface through a fairly large solid angle and arrive at each point of the large-area projected image through a correspondingly small solid angle, so that the throughput or "area-solid-angle product" at each reference surface is the same.

A good illustration, with still a different reference surface, other than that at the source or its image, is provided by a simple lens used as a "burning glass" to focus the sun's rays into a very small, hot image of the sun (see figure 2.12). The area  $A_L$  of the lens is very much larger than the area  $A_S$  of the sun's image, but the solid angle or projected solid angle (they are practically the same for small angles where  $\cos\theta \approx 1$ )  $\omega_{LS} \approx \Omega_{LS}$  subtended by the sun at the lens near the earth's surface is correspondingly very much smaller than the projected solid angle  $\Omega_{sL}$  corresponding to the solid angle of converging rays subtended at the sun's image by the lens. For the throughputs to be the same, the  $A \cdot \Omega$  products at both reference surfaces, i.e., at  $L$  and  $s$ , must be approximately equal:

$$A_L \cdot \Omega_{LS} \approx A_S \cdot \Omega_{sL} \text{ [m}^2 \cdot \text{sr)].} \quad (2.34)$$

The exact relationship, which is not so easily evaluated, is

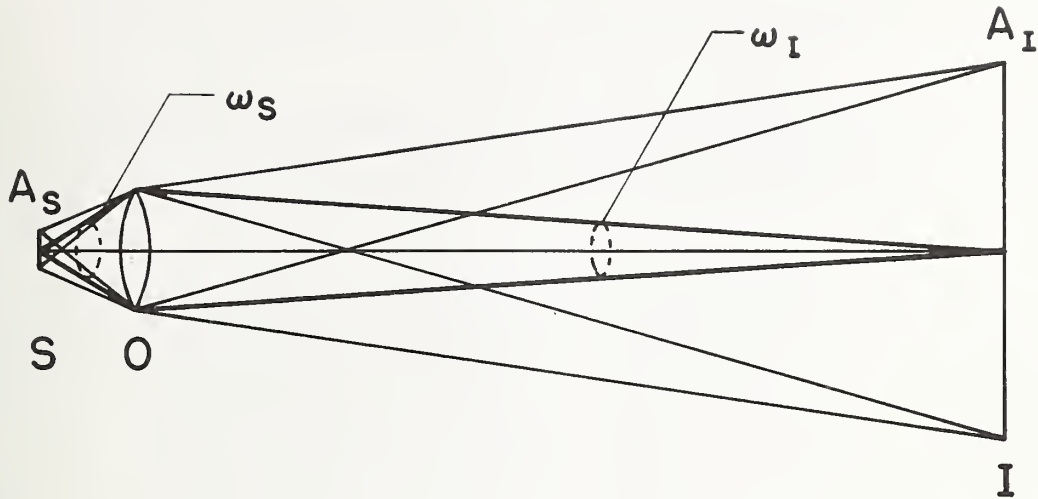

Figure 2.11. Slide-projector throughput.

S = slide

O = projection optics

I = image on projection screen

Throughput  $\Theta \approx A_S \cdot \Omega_S \approx A_I \cdot \Omega_I$  [ $\text{m}^2 \cdot \text{sr}$ ], where  
 projected solid angle  $\Omega \equiv \int_{\omega} \cos\theta \cdot d\omega \approx \omega$  [sr].

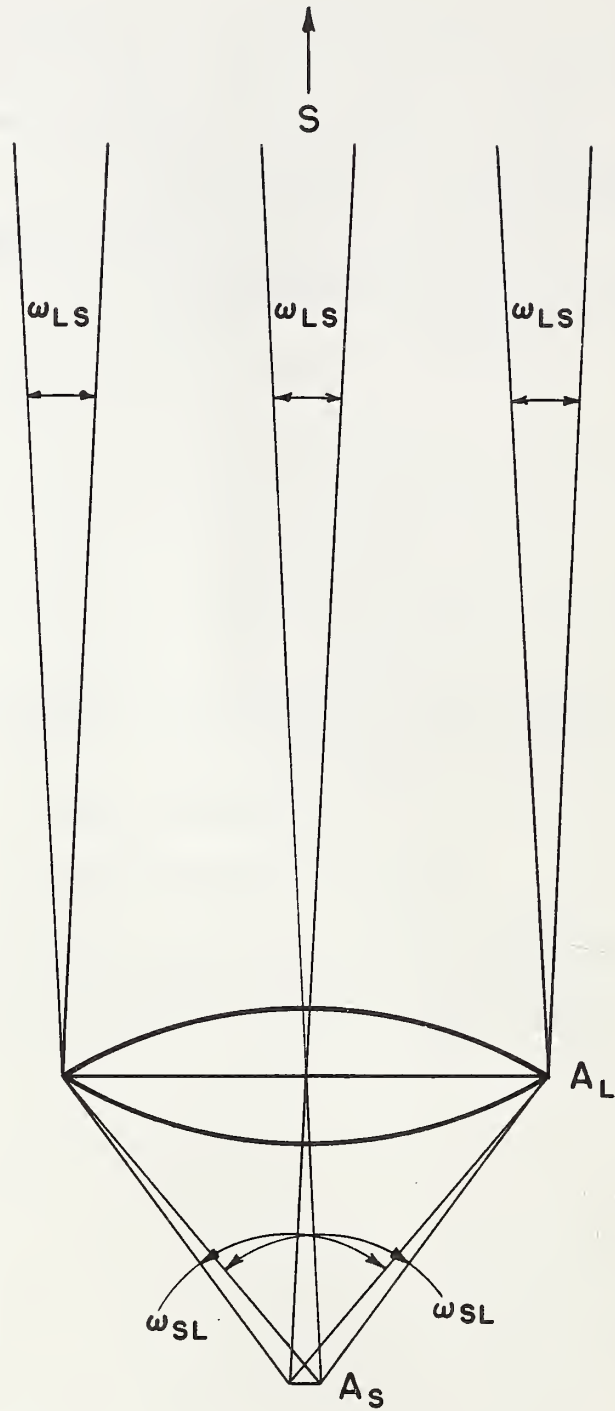

Figure 2.12. Burning-glass throughput.



$$\int_{A_L} \int_{\omega_{LS}} \cos\theta_{LS} \cdot d\omega_{LS} \cdot dA_L = \int_{A_s} \int_{\omega_{sL}} \cos\theta_{sL} \cdot d\omega_{sL} \cdot dA_s \quad [m^2 \cdot sr], \quad (2.35)$$

where the quantities on the left-hand side are evaluated over a reference surface at the lens L and those on the right-hand side are evaluated over a reference surface at the sun's image s, and where the subscript L refers to the lens, S to the sun, and s to the sun's image.

As with radiance, we've considered throughput first for uniform, isotropic media where the velocity of propagation (hence, the refractive index) is the same everywhere and in all directions so that rays are all straight lines. In the more general case, where the index of refraction changes from point to point along a ray, it is the element of basic throughput  $n^2 \cdot d\theta$ , rather than the element of throughput  $d\theta$ , that is invariant. This follows<sup>1</sup> immediately from the invariance of flux  $d\phi = L \cdot d\theta [= (L/n^2) \cdot (n^2 \cdot d\theta)]$  and the invariance of basic radiance  $L/n^2$ , when only ray geometry is considered and interactions with matter that may produce attenuation or augmentation are ignored. We won't make much use of basic throughput, however, It is mentioned here primarily for completeness. It is basic radiance that is usually more useful. Its geometrical invariance along each ray, together with functions taking into account any interactions with matter along the ray, provide the basis for transforming from the distribution of radiance across the intersection of a beam with one reference surface to the distribution at a second intersecting reference surface. Once the second distribution is known, the total flux in the beam at the second reference surface is correctly given by eq. (2.25), in terms of radiance (not basic radiance), even when the index of refraction  $n$  also varies from point to point over that reference surface.

OPTICAL PROPAGATION -- INTERACTIONS with MATTER. The propagation of optical radiation, especially the interactions with matter along the propagation path that can either attenuate (reduce) or augment (increase) the flux in a radiation beam, or do both simultaneously, could take up a separate chapter, or more. In fact, the complete, highly sophisticated treatment of radiative energy transfer, or just radiative transfer as it is usually termed, is beyond the scope of this Manual, but we will give it some attention later. Right now, we'll limit our treatment to the attenuation of radiance by absorption and/or by scattering or reflection into other directions. This will be adequate for a large majority of common measurement situations which do not involve optical paths through emitting or strongly scattering material nor the observation of weak sources that are close, at least in direction, to very much stronger ones. For example, amateur photographers are always cautioned, at least as beginners, to take pictures out of doors on clear days and not to point the camera near the sun. These restrictions still leave them with plenty of opportunities

---

<sup>1</sup>As pointed out in an earlier footnote concerning throughput, it is similarly possible to establish the invariance of basic throughput along a ray by purely geometrical reasoning, independently of the invariance of basic radiance. However, again, the logic used here is quite correct and much simpler.

for taking satisfactory pictures. Incidentally, photography is a rough form of optical radiation measurement. An ordinary photograph can be, and sometimes is, used as a measurement of the directional distribution of the radiance of the rays converging on the camera lens (the receiving aperture) from different parts of the angular field (the scene). However, reproducibility and calibration accuracy are not as good as with most other techniques. Nevertheless, it is frequently helpful to think of radiometric problems in terms of parallel situations in photography, with which many people have at least some familiarity.

To further simplify things in considering attenuation, we'll also confine our attention to optical paths that begin and end in the same medium. Then we can treat radiance  $L$  as the geometrical invariant. We need not concern ourselves with the refractive index and basic radiance as long as we are only interested in the initial and final values and not in the radiance within intermediate optical elements of different index.

Since an element of throughput  $d\theta$  is always invariant and is a purely geometrical quantity, unaffected by attenuation, any attenuation of the element of flux  $d\phi = L \cdot d\theta$ , as a ray propagates along an optical path, requires corresponding attenuation of the radiance  $L$ . For example, consider an element of flux  $d\phi_1$  reduced to  $d\phi_2 = \tau \cdot d\phi_1$  in traversing the path shown from surface 1 to surface 2 in figure 2.13. At each location, the flux element is the product of the radiance and the element of throughput:  $d\phi_1 = L_1 \cdot d\theta_1$  and  $d\phi_2 = L_2 \cdot d\theta_2$ . But  $d\theta_1 = d\theta_2 = d\theta$ , so

$$L_2 = d\phi_2/d\theta = \tau \cdot d\phi_1/d\theta = \tau \cdot L_1 \quad (2.36)$$

In this instance,  $\tau \equiv d\phi_2/d\phi_1 = L_2/L_1$ , the ratio of final radiance to initial radiance or the fraction of the initial radiance that is (successfully) transmitted, is the transmittance of the particular ray path. More generally, a complicated ray path may also include one or more points of regular (specular) reflectance where attenuation also takes place. A similar quantitative relation describes that situation, with reflectance  $\rho \equiv d\phi_r/d\phi_i = L_r/L_i$ , the ratio of reflected to incident radiance or the fraction of incident radiance that is (successfully) reflected, in place of transmittance. The corresponding ratio of final to initial radiances, as a measure of the attenuation due to all transmittances and reflectances over an extended path, the fraction of incident radiance that is (successfully) propagated over the entire path, is the propagance

$$\tau^* \equiv d\phi_p/d\phi_i = L_p/L_i, \quad (2.37)$$

where  $d\phi_p$  and  $L_p$  are the propagated quantities reaching the end of the ray path and  $d\phi_i$  and  $L_i$  are the initial quantities at the beginning of the ray path.

If the propagance is the same over all ray paths that make up a larger beam, it will have that same value for the entire beam. If not, the overall propagance for the entire beam, as the fraction of the total incident flux that is propagated to reach the end of the path, will be an average of the individual ray or elementary-beam propagances. It will

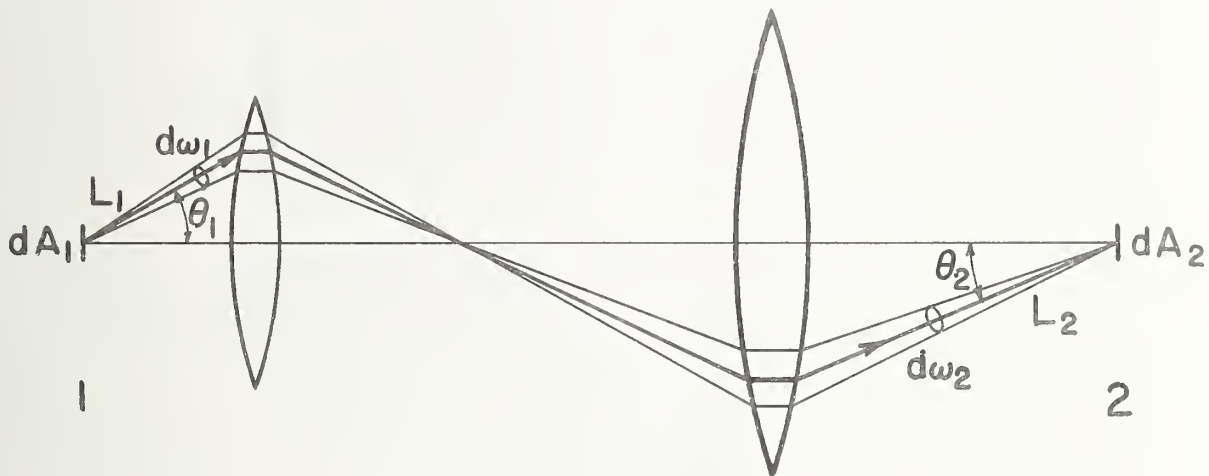

Figure 2.13. Transmittance of ray path

from  $dA_1$  to  $dA_2$  is

$$\tau \equiv d\phi_2/d\phi_1 = L_2/L_1,$$

where  $d\phi_i = L_i dA_i \cdot \cos\theta_i \cdot d\omega_i$

$$= L_i \cdot d\Omega; \quad i = 1 \text{ or } 2$$

be a simple average if the incident beam is uniform and isotropic, with all rays starting out with the same initial value of radiance  $L_i$ . If they do not, it will be a weighted average, with the spatial (position and direction) distribution of radiance  $L_i(x_i, y_i, \theta_i, \phi_i)$  as the weighting function.

Again, since we can't measure the radiance of a single ray or elementary beam, but only the average value for a beam of rays, we can't measure the ray or elementary-beam propagation, only the average value for a beam. However, the individual-ray or elementary-beam concept is regarded as the more basic for analysis. It is only in terms of individual rays that we can completely analyze and account for the behavior of non-uniform distributions interacting with non-uniform media and, finally, with radiometric instruments whose responsivities may also vary with the position and direction of each incident elementary beam at their receiving apertures.

TRANSFORMATION from KNOWN RADIANCE DISTRIBUTION to FLUX at ANOTHER LOCATION. A frequently encountered problem in making optical radiation measurements is to transform from a known distribution of radiance across the intersection of a beam with one reference surface to the corresponding distribution and its integral, the flux, across the intersection of the same beam with another reference surface. For example, given the distribution of radiance from a known source, e.g., a standard for which a certificate has been issued by NBS, what is the distribution of incident radiance at the surface of a receiver after the beam has passed through an atmosphere and optical elements for which the overall path propagation is known for each ray of the beam? Or, conversely, given the measured values of radiance as a function of position and direction over a reference surface, measured by a scanning or imaging radiometer, and the measured values of path propagation to a reference surface at the source, what is the corresponding radiance distribution and its integral, the emitted flux, at the source?

The first step, in either case, is to establish corresponding coordinates for ray position (point of intersection) and direction, between reference surfaces intersecting the beam at the two locations. We need to know, for all rays of the beam, the value of the coordinates of the point  $x_2, y_2$  and direction  $\theta_2, \phi_2$  where a ray intersects the second reference surface when given the coordinates of the point  $x_1, y_1$  and direction  $\theta_1, \phi_1$  for the same ray where it intersects the first reference surface, or vice versa. While not trivial, a table or formula for providing these corresponding coordinates for the same ray is often not a very difficult problem. In any event, it is a ray-tracing problem for which adequate treatments should be readily available in texts and references on geometrical optics, so we won't go into it any further at this point. Particular situations will be covered in Part III, when we go more thoroughly into applications. What concerns us now is that either set of coordinates,  $x_1, y_1, \theta_1, \phi_1$  or  $x_2, y_2, \theta_2, \phi_2$ , unambiguously identifies the same ray. Hence we may express any property of that ray in terms of either set of coordinates, or, even another set, as convenient. For example, we can express the radiance of a given ray at the second location as a function of the coordinates of that ray at the first location,  $L_2(x_1, y_1, \theta_1, \phi_1)$ , and vice versa,  $L_1(x_2, y_2, \theta_2, \phi_2)$ . Accordingly,

we'll drop the subscripts from the coordinates and show them just as  $x, y, \theta, \phi$ . They can be the coordinates at *any* convenient reference surface that intersects the beam. Of course, the same set must be used consistently for all quantities relating to the same rays in a given expression in order to establish meaningful relationships.

On this basis, we can write the propogance for a given ray, as a function of its coordinates, from eq. (2.37), as

$$\tau^*(x, y, \theta, \phi) \equiv L_p^{\circ}(x, y, \theta, \phi) / L_i(x, y, \theta, \phi). \quad (2.38)$$

Then, if we know the exitent propagated radiance  $L_p(x, y, \theta, \phi)$  and the ray-path propogance  $\tau^*(x, y, \theta, \phi)$ , the incident initial radiance is

$$L_i(x, y, \theta, \phi) = L_p(x, y, \theta, \phi) / \tau^*(x, y, \theta, \phi) [W \cdot m^{-2} \cdot sr^{-1}]. \quad (2.39)$$

Conversely, when the incident radiance  $L_i(x, y, \theta, \phi)$  and propogance  $\tau^*(x, y, \theta, \phi)$  are known, the exitent propagated radiance is found as

$$L_p(x, y, \theta, \phi) = \tau^*(x, y, \theta, \phi) \cdot L_i(x, y, \theta, \phi) [W \cdot m^{-2} \cdot sr^{-1}]. \quad (2.40)$$

Often the quantity that is finally desired is not the detailed distribution of radiance but the integrated total flux in the beam at the desired location. The corresponding expressions are the integrals of the quantities in eqs. (2.39) and (2.40), respectively. The integration is carried out over the area  $A$  containing all points of intersection  $x, y$  on the selected reference surface and over the solid angle  $\omega$  at each point  $x, y$  that includes the directions  $\theta, \phi$  for all rays of the beam that pass through that point of intersection.

$$\Phi_i = \int_A \int_{\omega} [L_p(x, y, \theta, \phi) / \tau^*(x, y, \theta, \phi)] \cdot \cos\theta \cdot d\omega \cdot dA [W]. \quad (2.41)$$

$$\Phi_p = \int_A \int_{\omega} L_i(x, y, \theta, \phi) \cdot \tau^*(x, y, \theta, \phi) \cdot \cos\theta \cdot d\omega \cdot dA [W]. \quad (2.42)$$

It should be reemphasized that these equations are based on the assumption that each pair of values of the radiances  $L_i$  and  $L_p$  for the same ray (same value of  $x, y, \theta, \phi$ ) exist at points of that ray where the refractive index is the same (in the same medium). If this is not the case, the transformations must be modified to take into account the different refractive indices at the two locations.<sup>1</sup>

<sup>1</sup>If  $n_i$  is the refractive index at the beginning of the propagation path,  $n_p$  the index at the end of the path, and  $n$  the index at the location of the intersecting reference surface for the coordinates  $x, y, \theta, \phi$ , these relations become:

$$\begin{aligned}\tau^*(x, y, \theta, \phi) &\equiv d\phi_p(x, y, \theta, \phi)/d\phi_i(x, y, \theta, \phi) = (L_p \cdot d\theta_p)/(L_i \cdot d\theta_i) \\ &= \frac{(L_p/n_p^2) \cdot (n_p^2 \cdot d\theta_p)}{(L_i/n_i^2) \cdot (n_i^2 \cdot d\theta_i)} = (L_p/L_i) \cdot (n_i^2/n_p^2),\end{aligned}\quad (2.37a)$$

since, by the invariance of basic throughput,  $n_p^2 \cdot d\theta_p = n_i^2 \cdot d\theta_i$ . Then

$$\phi_i = \int_A \int_{\omega} [L_p(x, y, \theta, \phi)/\tau^*(x, y, \theta, \phi)] \cdot (n^2/n_p^2) \cdot \cos\theta \cdot d\omega \cdot dA [W], \quad \text{and} \quad (2.41a)$$

$$\phi_p = \int_A \int_{\omega} L_i(x, y, \theta, \phi) \cdot \tau^*(x, y, \theta, \phi) \cdot (n^2/n_i^2) \cdot \cos\theta \cdot d\omega \cdot dA [W]. \quad (2.42a)$$

---

SUMMARY of CHAPTER 2. In order to obtain an expression for the amount of radiant (luminous or photon) flux propagated along a ray, we first introduce radiance (luminance) as the complete distribution of optical radiation with respect to the spatial parameters of position and direction. It is defined at a point on a reference surface in the direction of a ray through that point as (see figure 2.7)

$$L(x, y, \theta, \phi) \equiv \frac{d^2\phi(x, y, \theta, \phi)}{dA \cdot \cos\theta \cdot d\omega} [W \cdot m^{-2} \cdot sr^{-1}]. \quad (2.14)$$

This quantity, radiance, is geometrically invariant along any ray, in the direction of the ray, in a uniform, isotropic, passive, lossless medium. Across smooth boundaries between different media, or in media with varying refractive index, it is the basic radiance  $L/n^2$  (where  $n$  is the index of refraction at the point where the radiance is  $L$ ) that is similarly invariant along any ray. However, in the same medium (same refractive index), even after propagation through another, e.g., through an optical element of different index, just the radiance  $L$  is invariant (neglecting attenuation), with the same value in the direction of a ray at all points of the ray in that medium (e.g., air).

The element of flux associated with a ray is given by

$$d\phi(x, y, \theta, \phi) = L(x, y, \theta, \phi) \cdot \cos\theta \cdot d\omega \cdot dA [W] \quad (2.24)$$

$$= L \cdot d\theta [W], \quad (2.29)$$

where  $d\theta \equiv \cos\theta \cdot d\omega \cdot dA [m^2 \cdot sr]$  (2.28)

is the element of throughput associated with the ray through the point  $x, y$  in the direction  $\theta, \phi$ . The throughput element  $d\theta$  is also geometrically invariant along the ray at all points in the same medium (same index  $n$ ).

In order to evaluate the total flux  $\phi$  in a beam of radiation where it intersects some convenient reference surface, it is necessary to know the distribution of radiance over both the full area  $A$ , and the solid angle  $\omega$  at each point of that area, that

include all of the rays that make up the beam. The total flux in the intersecting beam is, then,

$$\Phi = \int_A \int_{\omega} L(x,y,\theta,\phi) \cdot \cos\theta \cdot d\omega \cdot dA \quad [W]. \quad (2.25)$$

If that radiance distribution is known only at another reference surface, it can be transformed to the desired values through the invariance of (basic) radiance along each ray of the beam, taking into account also interactions with matter over the intervening propagation paths that may attenuate or augment the radiance of each ray. Usually, the points of interest will both lie in the same medium (same refractive index; e.g., in air) where radiance is invariant, with no need to resort to basic radiance and refractive indices. Also, most radiation measurement situations involve direct paths through passive media where the only interactions are those that produce attenuation. For our purposes, the most convenient measure of the result of that attenuation is the propagation

$$\tau^*(x,y,\theta,\phi) \equiv L_p(x,y,\theta,\phi) / L_i(x,y,\theta,\phi) \quad (2.38)$$

over the ray path from the point  $x_i, y_i$ , where an incident ray, of radiance  $L_i(x_i, y_i, \theta_i, \phi_i)$ , intersects a reference surface in the direction  $\theta_i, \phi_i$ , to the point  $x_p, y_p$ , where the same ray intersects a second reference surface in the direction  $\theta_p, \phi_p$  with propagated radiance  $L_p(x_p, y_p, \theta_p, \phi_p)$ . Either set of coordinates  $x_i, y_i, \theta_i, \phi_i$  or  $x_p, y_p, \theta_p, \phi_p$ , or even those at a third reference surface (also in the same medium--same index) that intersects the entire beam, may be used in eq. (2.36), so the subscripts have been dropped there. It is only necessary to use, consistently, for all quantities in the same equation, such coordinates that uniquely identify each ray by its point of intersection and its direction with respect to the same reference surface.

Given (1) the incident radiance distribution  $L_i(x,y,\theta,\phi)$  at a reference surface, e.g., the surface of a source, and (2) the propagation  $\tau^*(x,y,\theta,\phi)$  of each ray over the path from its intersection with the first reference surface to its intersection with a second reference surface, e.g., the surface of a receiver, the transformation to the distribution of propagated radiance  $L_p(x,y,\theta,\phi)$  across the second reference surface is

$$L_p(x,y,\theta,\phi) = L_i(x,y,\theta,\phi) \cdot \tau^*(x,y,\theta,\phi) \quad [W \cdot m^{-2} \cdot sr^{-1}]. \quad (2.40)$$

Conversely, if the propagated radiance distribution has been measured and the transformation back to the incident radiance distribution at the first reference surface is desired, it is

$$L_i(x,y,\theta,\phi) = L_p(x,y,\theta,\phi) / \tau^*(x,y,\theta,\phi) \quad [W \cdot m^{-2} \cdot sr^{-1}]. \quad (2.39)$$

Finally, the corresponding transformations to obtain the integrated total flux in the beam at the second location, in each case, are, respectively,

$$\phi_p = \int_A \int_{\omega} L_i(x, y, \theta, \phi) \cdot \tau^*(x, y, \theta, \phi) \cdot \cos\theta \cdot d\omega \cdot dA \quad [W] \quad (2.42)$$

and

$$\phi_i = \int_A \int_{\omega} [L_p(x, y, \theta, \phi) / \tau^*(x, y, \theta, \phi)] \cdot \cos\theta \cdot d\omega \cdot dA \quad [W]. \quad (2.41)$$

It is assumed that both reference surfaces are in the same medium (same refractive index) as well as any third reference surface that might be used for the ray coordinates in an unusual situation. If this is not the case, see eqs. (2.41a) and (2.42a) in the footnote at the end of the last paragraph preceding this Summary.



### Chapter 3. Spectral Distribution of Optical Radiation

by Fred E. Nicodemus and Henry J. Kostkowski

In this CHAPTER. We develop the concept of spectral radiance. This is the basic quantity for specifying the distribution of radiation relative to wavelength and, at the same time, relative to position and direction. We examine the interrelationships between spectral radiance and radiance, particularly in relation to geometrical invariance along a ray. Finally, we look at the way in which the total flux in a beam is evaluated from the distribution of spectral radiance. In the main, this is almost a duplication of the treatment in Chapter 2 except for the addition of the new variable. However, we've spelled it all out in much the same detail again for those who want it. Those who prefer to do so can skip directly to the summary at the end of the Chapter and use it to decide what, if any, details they need to review more fully in the body of the Chapter.

SPECTRAL RADIANCE. In general, the optical radiation emitted by most sources, the propagation over many paths, and the responsivity of many detectors, all can vary greatly with the spectral parameter, wavelength.<sup>1</sup> The combined result of all such effects of wavelength (spectral) variations involved in a measurement is usually substantially greater than the effects of geometrical variations (variations in ray position and direction). An example of the degree of variation that can occur is seen in figure 3.1 which shows the spectral distribution of the radiation emitted by the central, uniform portion of a 2750-K tungsten strip lamp and the spectral responsivity of a frequently used photomultiplier detector. The radiance of the lamp increases by a factor of 7.5 from 450 to 800 [nm] while the photomultiplier responsivity decreases by a factor of 30 over that same interval.

In order to extend the concept of radiance so that it also covers distribution with respect to wavelength, consider again the experiment illustrated in figures 2.2 and 2.3,

---

<sup>1</sup>The spectral parameter is commonly given in three different ways. They are (1) frequency  $\nu$  ( $=c/\lambda_0$ ) [THz], (2) wavelength  $\lambda$  [nm], and (3) wave number  $\sigma$  ( $=1/\lambda_0$ ) [ $\text{cm}^{-1}$ ] (where  $c \approx 3 \times 10^8$  [ $\text{m} \cdot \text{s}^{-1}$ ] is the vacuum speed of electro-magnetic radiation,  $\lambda_0$  ( $=n \cdot \lambda$ ) [nm] is the wavelength in vacuum, and  $n$  is the index of refraction). The units shown are those typically used in each case, but they are not consistent. For  $\nu = c/\lambda_0$  to be in [THz] with  $\lambda_0$  in [nm], we must use  $c \approx 3 \times 10^5$  [ $\text{km} \cdot \text{s}^{-1}$ ], and for  $\sigma = 1/\lambda_0$  to be in [ $\text{cm}^{-1}$ ] it is obvious that  $\lambda_0$  must be given in [cm]. Incidentally, these wave-number units, widely used by spectroscopists, are called "reciprocal centimeters." Although frequency  $\nu$  is the basic spectral parameter, that remains unchanged as a ray passes through different media, we will follow common practice by expressing most spectral quantities in radiometry in terms of wavelength. Note, also, that the term "spectral," itself, can be ambiguous; there are also space-frequency spectra, referring to repeating patterns in the spatial distribution of radiance, and modulation- or scintillation-frequency spectra, referring to frequencies  $f \ll \nu$  [Hz] of variation in the average radiant flux or power in a radiation beam. We will consistently use "spectrum" or "spectra" and "spectral" alone, without a modifier, only to refer to the radiation parameters  $\nu$ ,  $\lambda$ , and/or  $\sigma$ .

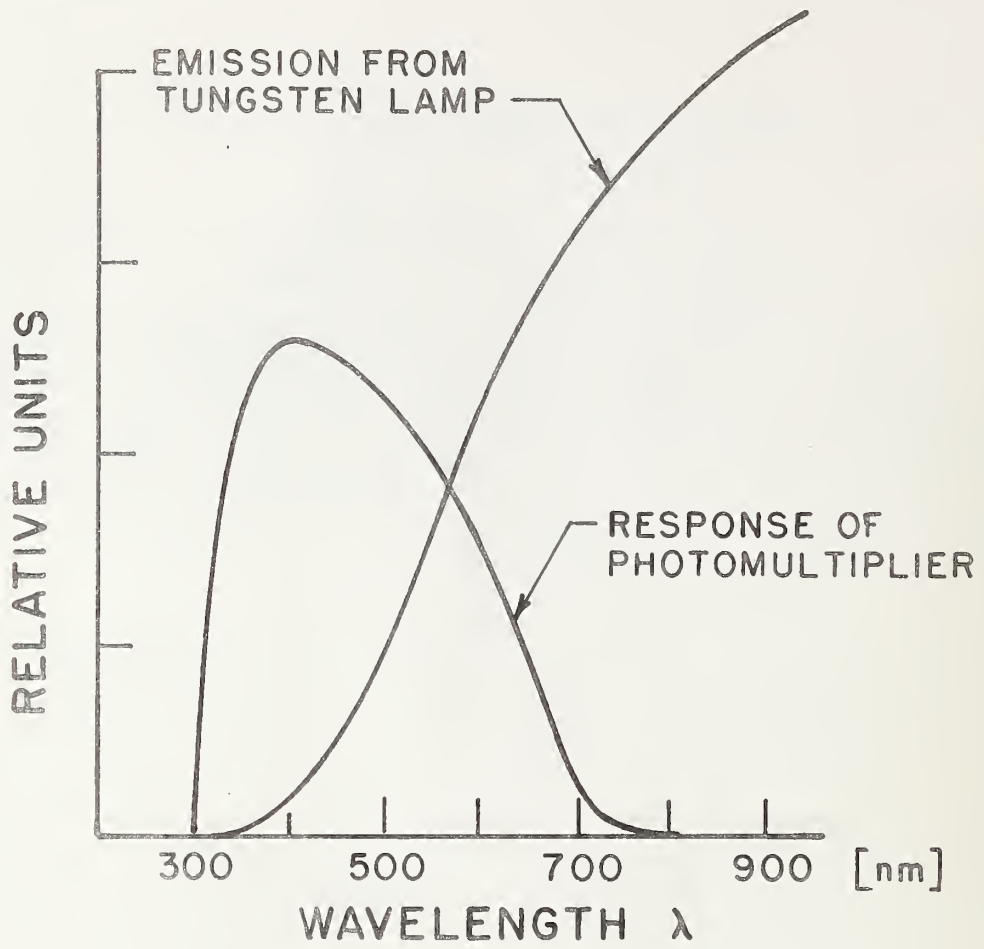

Figure 3.1. Large variations of radiometric quantities with respect to wavelength.

where we found that the flux in the beam defined by two small apertures is given approximately by

$$\Delta\Phi \approx L \cdot \frac{\Delta A_1 \cdot \cos\theta_1 \cdot \Delta A_2 \cdot \cos\theta_2}{D^2} \quad [W] \quad (2.3)$$

(this time we use the "approximately equals" sign to clearly recognize that this is an approximation). Now, in this same experiment, we insert into the beam, one at a time, filters that are transparent (transmittance  $\tau = 1$ ) only to certain desired wavelengths and are opaque (transmittance  $\tau = 0$ ) to all other wavelengths, completely blocking them, as shown in figure 3.2. Of course, real filters can only approximate those ideal characteristics, but it's useful to make the assumptions for analysis to clarify the related concepts. With such a set of filters, of successively decreasing spectral intervals (bandwidths)  $\Delta\lambda$  about the same central wavelength  $\lambda_c$ , we find that the measured flux  $\Delta\Phi$  in the beam is now approximately proportional to the spectral-wavelength bandwidth  $\Delta\lambda$ , as well as to the spatial factors, as before. Also, as with the spatial parameters, as the wavelength interval decreases, the proportionality becomes more exact. In fact, we find that, even though we are stopped again by the minimum amount of flux  $\Delta\Phi$  required for any measurement to be made, it is once more analytically useful to assume a continuous underlying distribution to which the limiting process of calculus is applicable. Accordingly, we assume that, when the spectral interval is made arbitrarily small, the proportionality is exact and the proportionality constant is called spectral radiance (more explicitly, spectral-wavelength radiance) and is denoted and defined as

$$\begin{aligned} L_\lambda &= \lim_{\substack{\Delta\lambda \rightarrow 0 \\ \Delta A_1 \rightarrow 0 \\ \Delta A_2 \rightarrow 0}} \frac{\Delta\Phi}{(\Delta\lambda \cdot \Delta A_1 \cdot \cos\theta_1 \cdot \Delta A_2 \cdot \cos\theta_2) / D^2} \\ &= \frac{d^3\Phi}{(d\lambda \cdot dA_1 \cdot \cos\theta_1 \cdot dA_2 \cdot \cos\theta_2) / D^2} \end{aligned} \quad (3.1)$$

These relations correspond to those in eqs. (2.5) and (2.6) and, like them, are important aids for many who find this approach to the concepts easier to understand. Later, however, for useful applications, we'll go back to the approach of eq. (2.12) and employ the equivalent expressions in terms of position and direction at a single location.

From eqs. (2.6) and (3.1), it is clear that spectral radiance is the spectral distribution<sup>1</sup> of radiance, the spectral concentration per unit wavelength interval as a function of

---

<sup>1</sup>The CIE-IEC International Lighting Vocabulary [5] does not use the term "spectral radiance." Instead, it speaks of the value at a particular wavelength as a "spectral concentration of radiance" and of the spectral concentration as a function of wavelength as the "spectral distribution of radiance." However, we follow the widespread practice in this country in our use of the term "spectral radiance" for both of these quantities.

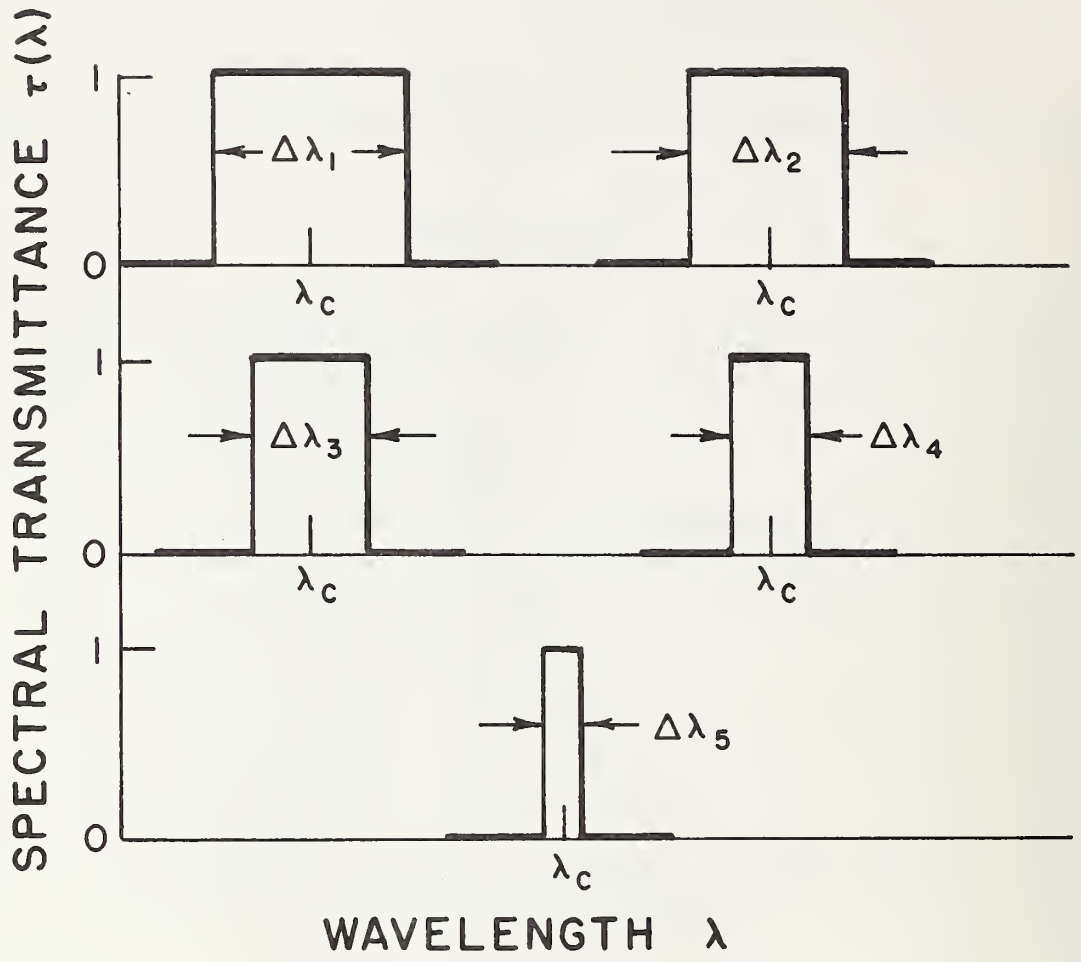

Figure 3.2. Ideal filter set with spectral transmittances all centered about the same  $\lambda_c$ .

wavelength

$$L_{\lambda}(\lambda') = \left. \frac{dL}{d\lambda} \right|_{\lambda'}. \quad (3.2)$$

Accordingly, it provides a means for specifying the distribution of optical radiation with respect to wavelength and, at the same time, with respect to position and direction. Furthermore, by integrating both sides of eq. (3.2), the value of radiance in a wavelength band from  $\lambda_1$  to  $\lambda_2$  is obtained as

$$L_{(\lambda_1-\lambda_2)} = \int_{\lambda_1}^{\lambda_2} L_{\lambda} \cdot d\lambda. \quad (3.3)$$

For example, the wavelength distributions of emitted radiation for three frequently used light sources are plotted on relative scales in figure 3.3. If the ordinate scales were adjusted to represent values of spectral radiance, the areas under each curve between limiting wavelengths  $\lambda_1$  and  $\lambda_2$ , i.e., the integrals of eq. (3.3) between those limits, would represent the emitted radiance in that spectral-wavelength band for each lamp.

As with radiance, we want to define and work with spectral radiance as the property of a ray at its intersection with a reference surface (figure 2.7). Again, recognizing that  $(\Delta A_2 \cdot \cos\theta_2)/D^2 = \Delta\omega_{12}$  is the solid angle<sup>1</sup> in steradians [sr] subtended at  $\Delta A_1$  by  $\Delta A_2$ , as shown in figure 2.6, we can rewrite eq. (3.1) as

$$\begin{aligned} L_{\lambda} &= \lim_{\substack{\Delta A \rightarrow 0 \\ \Delta\omega \rightarrow 0 \\ \Delta\lambda \rightarrow 0}} \frac{\Delta\phi}{\Delta A \cdot \cos\theta \cdot \theta\omega \cdot \Delta\lambda} \\ &= \frac{d^3\phi}{dA \cdot \cos\theta \cdot d\omega \cdot d\lambda} \quad [W \cdot m^{-2} \cdot sr^{-1} \cdot nm^{-1}]. \end{aligned} \quad (3.4)$$

The SI units for spectral radiance are often given as  $[W \cdot m^{-3} \cdot sr^{-1}]$ , using the same unit of length (meter [m]) for wavelength as for other distances. However, it then appears, misleadingly, to be a volume concentration, which it certainly is not.<sup>2</sup> (In fact, we'll see later that there is a radiometric quantity called "steriscent" that is correctly given just

<sup>1</sup>See Appendix 2 for definition and discussion of the concept of solid angle.

<sup>2</sup>Similarly, if the wave-number unit is given as the reciprocal meter  $[m^{-1}]$ , the unit of spectral (wave-number) radiance  $L_{\sigma} \equiv dL/d\sigma$  would be  $[W \cdot m^{-1} \cdot sr^{-1}]$ , rather than  $[W \cdot m^{-2} \cdot sr^{-1} \cdot cm]$ , as we prefer it because it correctly suggests a simultaneous distribution with respect to area, solid angle, and wave number. An earlier footnote suggests that frequency  $\nu$  [THz] be regarded as the basic spectral parameter. From that standpoint, wavelength and wave number can be considered as indirect measures of frequency, rather than as lengths or reciprocal lengths, per se, as further justification for treating them as having different dimensionality from other lengths.

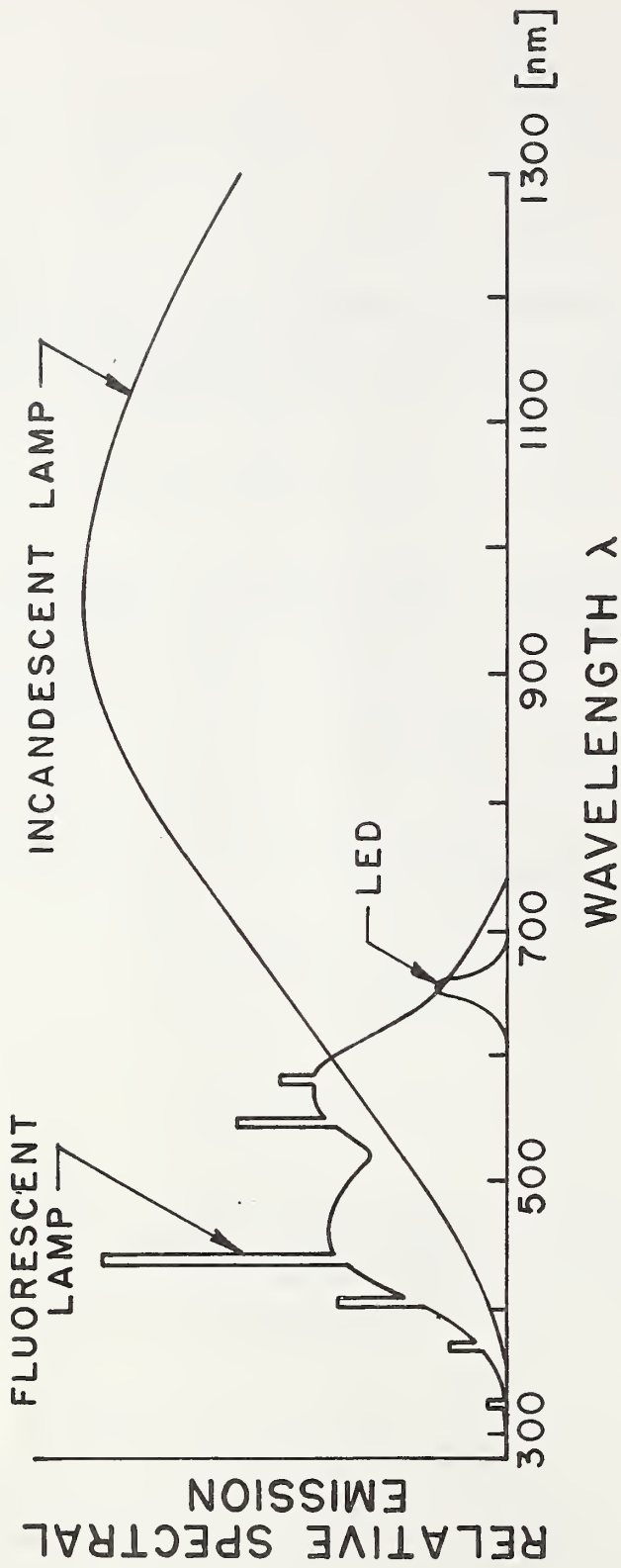

Figure 3.3. Spectral distribution of emission for three typical light sources in relative units. (There is no significance to the height of any curve relative to the others.)

those units and is quite correctly treated as a volume concentration.) Accordingly, we prefer to use a different length unit (also of more appropriate magnitude), the nanometer [nm], for wavelengths and thus make it easier to recognize and keep track of the different dimensionality of the spectral parameter in checks of unit-dimension consistency.

The fully explicit defining equation for spectral radiance, then, is

$$L_{\lambda}(x,y,\theta,\phi,\lambda) \equiv \frac{d^3\phi(x,y,\theta,\phi,\lambda)}{dA \cdot \cos\theta \cdot d\omega \cdot d\lambda} [W \cdot m^{-2} \cdot sr^{-1} \cdot nm^{-1}], \quad (3.5)$$

where

$x,y,\theta,\phi$  are defined, relative to the intersecting ray and surface element  $dA$ , in connection with eq. (2.13) (and figure 2.7);

$L_{\lambda}(x,y,\theta,\phi,\lambda) [W \cdot m^{-2} \cdot sr^{-1} \cdot nm^{-1}]$  is the spectral radiance at the point  $x,y$  in the direction  $\theta,\phi$  and at the wavelength  $\lambda$ ; and

$d^3\phi(x,y,\theta,\phi,\lambda) [W]$  is the radiant flux through the surface element  $dA = dx \cdot dy [m^2]$  about the point  $x,y$  within the element of solid angle  $d\omega = \sin\theta \cdot d\theta \cdot d\phi [sr]$  in the direction  $\theta,\phi$  and within the elementary wavelength interval  $d\lambda [nm]$  about the wavelength  $\lambda$ .

GEOMETRICAL INVARIANCE of SPECTRAL RADIANCE. In the last chapter, considering only the spatial parameters of position and direction, we found that the basic radiance  $L/n^2$  is invariant along any ray, in the direction of that ray, in lossless passive media where the index of refraction may vary and where its value is  $n$  at the point where the radiance is  $L$ . The same is true for the basic spectral radiance  $L_{\nu}/n^2$  or  $L_{\sigma}/n^2$ , in terms of frequency  $\nu$  or wave number  $\sigma$ , respectively.<sup>1</sup> However, wavelengths depend on the refractive index of the medium, so that  $\lambda(n) = \lambda_0/n$  where  $\lambda(n)$  is the wavelength in a medium of refractive index  $n$ , and  $\lambda_0$  is the wavelength of the same ray in a vacuum. To see how this affects the invariance of the spectral radiance  $L_{\lambda} \equiv dL/d\lambda$ , let's go back to the situation depicted in figure 2.9. We now assume that the incident ray contains only wavelengths in an elementary spectral interval  $d\lambda_1 = d\lambda_0/n_1$  so that its radiance, in terms of the incident spectral radiance  $L_{\lambda_1}$ , is given by

$$dL_1 = L_{\lambda_1} \cdot d\lambda_1 = L_{\lambda_1} \cdot d\lambda_0/n_1. \quad (3.6)$$

Similarly, the refracted radiance in the second medium, of index  $n_2$ , is now given, in terms of the refracted spectral radiance  $L_{\lambda_2}$ , by

$$dL_2 = L_{\lambda_2} \cdot d\lambda_2 = L_{\lambda_2} \cdot d\lambda_0/n_2. \quad (3.7)$$

According to eq. (2.22), these values of radiance are related by

$$\frac{dL_1}{n_1^2} = \frac{dL_2}{n_2^2} \quad (3.8)$$

<sup>1</sup>See Footnote 2 on p. 49.

in which we can substitute from eqs. (3.6) and (3.7) and cancel the common value of  $d\lambda_0$  to obtain

$$\frac{L_{\lambda_1}}{n_1^3} = \frac{L_{\lambda_2}}{n_2^3}. \quad (3.9)$$

The invariant or basic spectral-wavelength radiance, in terms of local wavelength  $\lambda(n)$  in a medium of varying refractive index  $n$ , is, thus,  $L_\lambda/n^3$  (not  $L_\lambda/n^2$ ). Some workers, however, prefer to deal with this problem by expressing all spectral quantities in terms of vacuum wavelength  $\lambda_0 = n \cdot \lambda(n)$  and then using the basic spectral radiance in the form  $L_{\lambda_0}/n^2$ . Also, in a dispersive medium, where the refractive index varies significantly with wavelength as  $n(\lambda)$  or  $n(\lambda_0)$ , the value of  $n$  that would make the basic radiance  $L/n^2$  invariant depends on the spectral content of the radiance  $L = \int L_\lambda \cdot d\lambda$ , which may also vary along a ray. If the medium is highly dispersive, the variation of  $n$  with  $\lambda$  can also significantly affect  $L_\lambda/n^3$ , although the discrepancy is insignificant in air at room temperatures. However, the basic spectral radiance in terms of  $\lambda_0$ ,  $\nu$ , or  $\sigma$  is  $L_{\lambda_0}/n^2$ ,  $L_\nu/n^2$ , or  $L_\sigma/n^2$ , respectively, and is geometrically invariant along each ray in all instances.

TOTAL FLUX in a RADIATION BEAM. From eq. (3.5), we can write the expression for the element of flux  $d\Phi(x,y,\theta,\phi,\lambda)$  along a ray of spectral radiance  $L_\lambda(x,y,\theta,\phi,\lambda)$  through an element of surface  $dA = dx \cdot dy$  at its point of intersection  $x,y$  with the ray and within an element of solid angle  $d\omega = \sin\theta \cdot d\theta \cdot d\phi$  about the ray in the direction  $\theta,\phi$  and also within a spectral-wavelength element  $d\lambda$  about the wavelength  $\lambda$ . It is

$$\begin{aligned} d\Phi(x,y,\theta,\phi,\lambda) &= L_\lambda(x,y,\theta,\phi,\lambda) \cdot \sin\theta \cdot d\omega \cdot dA \cdot d\lambda \\ &= L_\lambda \cdot d\theta \cdot d\lambda \text{ [W]}, \end{aligned} \quad (3.10)$$

the counterpart of eqs. (2.23) and (2.28), now also taking account of spectral-wavelength variations and functional dependence. Then, if we know the distribution of spectral radiance  $L_\lambda(x,y,\theta,\phi,\lambda)$  over an area  $A$  that includes all points of intersection  $x,y$  between rays of a given beam and some reference surface, over a solid angle  $\omega$  at each point  $x,y$  that contains all directions  $\theta,\phi$  for rays of the beam that pass through that point, and over a wavelength interval  $\Delta\lambda$  that includes all wavelengths  $\lambda$  for which there is a significant amount of spectral radiance,<sup>1</sup> the total flux  $\Phi$  in the beam at its intersection with the reference surface is given by

$$\Phi = \int_A \int_\omega \int_{\Delta\lambda} L_\lambda(x,y,\theta,\phi,\lambda) \cdot d\lambda \cdot \cos\theta \cdot d\omega \cdot dA \text{ [W]}. \quad (3.11)$$

<sup>1</sup>Strictly, the integration should cover all wavelengths  $\lambda$  for which  $L_\lambda \neq 0$ . Also, use of the symbol  $\Delta\lambda$  in no way implies that the interval is small; it may be of any size.



This is the counterpart of eq. (2.24), to which the spectral-wavelength dependence has now been added. For a more completely explicit expansion of this triple integral, see the footnote below eq. (2.24) or Appendix 2.

At the beginning of this Chapter, we called attention to the wide spectral variations that commonly occur. It is quite unusual for the spectral radiance  $L_\lambda(\lambda)$  of a source to be a constant over a wide band of wavelengths. However, there are many situations where the radiance  $L = \int_\lambda L_\lambda(\lambda) \cdot d\lambda$  is a constant, to a useful degree of approximation (practically uniform and isotropic) throughout a beam of radiation. Hence, even when there is a significant spectral variation, the relationships given in eqs. (2.25) through (2.33) may be applicable and are often useful.

TRANSFORMATION from KNOWN SPECTRAL-RADIANCE DISTRIBUTION to FLUX at ANOTHER LOCATION. We've already seen that detector response can be highly variable as a function of the spectral parameter, wavelength. The same is true of other interactions with matter that produce attenuation along a propagation path. Accordingly, eq. (2.36) must now be rewritten to define the spectral-directional propogance for a ray through the point  $x,y$  in the direction  $\theta,\phi$  and of wavelength  $\lambda$  (at that point and in that direction) as

$$\tau^*(x,y,\theta,\phi,\lambda) \equiv L_{\lambda,p}(x,y,\theta,\phi,\lambda)/L_{\lambda,i}(x,y,\theta,\phi,\lambda). \quad (3.12)$$

Similarly, eqs. (2.37) and (2.38) become, respectively,

$$L_{\lambda,i}(x,y,\theta,\phi,\lambda) = L_{\lambda,p}(x,y,\theta,\phi,\lambda)/\tau^*(x,y,\theta,\phi,\lambda) [W \cdot m^{-2} \cdot sr^{-1} \cdot nm^{-1}] \quad (3.13)$$

and

$$L_{\lambda,p}(x,y,\theta,\phi,\lambda) = L_{\lambda,i}(x,y,\theta,\phi,\lambda) \cdot \tau^*(x,y,\theta,\phi,\lambda) [W \cdot m^{-2} \cdot sr^{-1} \cdot nm^{-1}] \quad (3.14)$$

for the transformation from a known spectral radiance at one location to that at another location along the same ray when both points are in the same medium (same refractive index). Likewise, for the integrated total flux in the beam at the desired location, eqs. (2.39) and (2.40) become, respectively,

$$\phi_i = \int_A \int_\omega \int_{\Delta\lambda} [L_{\lambda,p}(x,y,\theta,\phi,\lambda)/\tau^*(x,y,\theta,\phi,\lambda)] \cdot d\lambda \cdot \cos\theta \cdot d\omega \cdot dA [W] \quad (3.15)$$

and

$$\phi_p = \int_A \int_\omega \int_{\Delta\lambda} L_{\lambda,i}(x,y,\theta,\phi,\lambda) \cdot \tau^*(x,y,\theta,\phi,\lambda) \cdot d\lambda \cdot \cos\theta \cdot d\omega \cdot dA [W]. \quad (3.16)$$

We reemphasize that these relations hold only when the point of incidence, where  $L_{\lambda,i}$  exists at the beginning of each ray path, and the point of exitence, where  $L_{\lambda,p}$  exists at the end of the ray path, are in the same medium (same refractive index). Also, because of the geometrical invariance of both the radiance and the associated element of throughput

along each ray, the reference surface for the coordinates  $x, y, \theta, \phi, \lambda$  may be at either location, or even at a third location, as long as the same coordinates and the area  $A$ , the solid angle  $\omega$ , and the wavelength interval  $\Delta\lambda$  (all containing only, and all, rays of the beam) are all consistently referred to the same reference surface at its intersection with the beam. Thus it is possible to choose the reference surface where these quantities are easiest to evaluate.

In the more general case, where the refractive indices at the points of incidence and exitence are not the same, the transformation must be based on the geometrical invariance of basic spectral radiance, taking into account those refractive indices, rather than on the invariance of spectral radiance as above. Otherwise, everything proceeds in the same way. It's all quite straightforward, but the expressions are longer and more complicated and they are seldom needed.

REMAINING RADIATION PARAMETERS -- TIME and POLARIZATION. The spatial and spectral parameters, which have now been covered, have traditionally received the most attention since their effects are almost always significant. On the other hand, we may often safely ignore the remaining parameters, time or frequency of fluctuation or scintillation, and polarization, especially when an uncertainty of a few per cent or more is adequate. Accordingly, we will put off our discussion of the remaining parameters for a while and turn, next, to the measurement equation, to more about spatial distributions, to thermal radiation, and to photometry. But we strongly caution the reader that, in doing so, we definitely are not recommending this as the ultimate or correct approach for accurate measurements. It is our conviction that many of the problems and inconsistencies that arise every day in connection with optical radiation measurements can be traced to these remaining parameters, particularly to polarization effects, that are too often ignored. We present things in this order because we feel that it will be easier for the reader to grasp the new concepts when they are presented in this way. But we strongly emphasize that, until all of the parameters are included, the treatment of the measurement equation and related topics must be regarded as only preliminary and incomplete. It will have a substantial area of usefulness, but the limitations on its usefulness must not be forgotten.

SUMMARY of CHAPTER 3. The distribution of optical radiation with respect to position, direction, and wavelength--the spectral-geometrical or spectral-spatial distribution--is spectral radiance

$$L_{\lambda}(\lambda') \equiv dL/d\lambda|_{\lambda}, [W \cdot m^{-2} \cdot sr^{-1} \cdot nm^{-1}] \quad (3.2)$$

or, more completely,

$$L_{\lambda}(x, y, \theta, \phi, \lambda) \equiv \frac{d^3\Phi(x, y, \theta, \phi, \lambda)}{dA \cdot \cos\theta \cdot d\omega \cdot d\lambda} [W \cdot m^{-2} \cdot sr^{-1} \cdot nm^{-1}]. \quad (3.5)$$

The spectral parameter of wavelength  $\lambda$  [nm] may be replaced in these defining equations by the more basic spectral parameter of frequency  $\nu$  [THz], or by the other spectral parameters of vacuum wavelength  $\lambda_0$  [nm] and wave number  $\sigma$  [cm<sup>-1</sup>], both of which also

remain constant during passage through different media (different refractive indices).<sup>1</sup>

Like radiance  $L$ , spectral radiance  $L_\lambda$  is geometrically invariant along any ray, in the direction of the ray, in an isotropic, passive, lossless medium. In media of varying refractive index  $n$ , the invariant basic spectral radiance depends on the spectral parameter. For frequency  $\nu$ , for wave number  $\sigma$ , and for those who transform always to the vacuum wavelength  $\lambda_0$ , it is  $L_\nu/n^2$ ,  $L_\sigma/n^2$ , and  $L_{\lambda_0}/n^2$ , respectively. However, for the spectral parameter of "local" wavelength  $\lambda(n)$ , where the refractive index is  $n$ , the basic spectral-wavelength radiance is  $L_\lambda/n^3$ .

The element of flux associated with a ray of spectral radiance  $L_\lambda$  is given by

$$\begin{aligned} d\phi(x,y,\theta,\phi,\lambda) &= L_\lambda(x,y,\theta,\phi,\lambda) \cdot \cos\theta \cdot d\omega \cdot dA \cdot d\lambda \text{ [W]} \\ &= L_\lambda \cdot d\theta \cdot d\lambda \text{ [W]}. \end{aligned} \quad (3.10)$$

The total flux in a beam, given the distribution of spectral radiance at its intersection with a convenient reference surface, is

$$\phi = \int_A \int_\omega \int_{\Delta\lambda} L_\lambda(x,y,\theta,\phi,\lambda) \cdot d\lambda \cdot \cos\theta \cdot d\omega \cdot dA \text{ [W]}. \quad (3.11)$$

Except for the fact that the additional radiation parameters, time or frequency of modulation or fluctuation and polarization, have been ignored, eqs. (3.10) and (3.11) are general relations of wide validity. In particular, they are not in any way dependent on the index of refraction.

For the simple transformations from a known spectral radiance or spectral-radiance distribution for the rays of a beam at one location to the distribution or the integrated value of flux in the same beam at another location, based on the geometrical invariance of spectral radiance, it is necessary that both locations (both intersecting reference surfaces) be in the same medium (same refractive index). The transformation relations are:

$$L_{\lambda,i}(x,y,\theta,\phi,\lambda) = L_{\lambda,p}(x,y,\theta,\phi,\lambda) / \tau^*(x,y,\theta,\phi,\lambda) \text{ [W}\cdot\text{m}^{-2}\cdot\text{sr}^{-1}\cdot\text{nm}^{-1}\text{]}, \quad (3.13)$$

$$L_{\lambda,p}(x,y,\theta,\phi,\lambda) = L_{\lambda,i}(x,y,\theta,\phi,\lambda) \cdot \tau^*(x,y,\theta,\phi,\lambda) \text{ [W}\cdot\text{m}^{-2}\cdot\text{sr}^{-1}\cdot\text{nm}^{-1}\text{]}, \quad (3.14)$$

$$\phi_i = \int_A \int_\omega \int_{\Delta\lambda} [L_{\lambda,p}(x,y,\theta,\phi,\lambda) / \tau^*(x,y,\theta,\phi,\lambda)] \cdot d\lambda \cdot \cos\theta \cdot d\omega \cdot dA \text{ [W]}, \quad (3.15)$$

and

$$\phi_p = \int_A \int_\omega \int_{\Delta\lambda} L_{\lambda,i}(x,y,\theta,\phi,\lambda) \cdot \tau^*(x,y,\theta,\phi,\lambda) \cdot d\lambda \cdot \cos\theta \cdot d\omega \cdot dA \text{ [W]}. \quad (3.16)$$

When the refractive indices at the two locations are not the same, similar but somewhat more complicated expressions must be used, based on the geometrical invariance of basic spectral radiance, taking into account those refractive indices.

<sup>1</sup>See footnote on first page of Chapter 3.

Appendix 1. Units and Unit Symbols

The base units of the International System (SI) are given in Table A1-1, which follows Table 1 of [16], except that we have added the square brackets enclosing each unit symbol. That practice was adopted to emphasize the dimensionality of the units and the usefulness of that dimensionality in routine unit-dimension-consistency checks and analyses to cope with the great diversity of nomenclature in the literature on optical radiation measurements.

Table A1-1

SI Base Units

<u>Quantity</u>	<u>Name</u>	<u>Symbol</u>
length . . . . .	meter . . . . .	[m]
mass . . . . .	kilogram . . . . .	[kg]
time . . . . .	second . . . . .	[s]
electric current . . . . .	ampere . . . . .	[A]
thermodynamic temperature . . . . .	kelvin . . . . .	[K]
amount of substance . . . . .	mole . . . . .	[mol]
luminous intensity . . . . .	candela . . . . .	[cd]

Of the SI base units, the one of particular interest in the branch of optical radiation measurements known as photometry is the candela, defined officially as follows: "The candela is the luminous intensity, in the perpendicular direction, of a surface of 1/600 000 square meter of a blackbody at the temperature of freezing platinum under a pressure of 101 325 newtons per square meter {13th CGPM (1967). Resolution 5}." [16].

Table A1-2

SI Prefixes

<u>Factor</u>	<u>Prefix</u>	<u>Symbol</u>	<u>Factor</u>	<u>Prefix</u>	<u>Symbol</u>
10 <sup>18</sup>	exa	E	10 <sup>-1</sup>	deci	d
10 <sup>15</sup>	peta	P	10 <sup>-2</sup>	centi	c
10 <sup>12</sup>	tera	T	10 <sup>-3</sup>	milli	m
10 <sup>9</sup>	giga	G	10 <sup>-6</sup>	micro	μ
10 <sup>6</sup>	mega	M	10 <sup>-9</sup>	nano	n
10 <sup>3</sup>	kilo	k	10 <sup>-12</sup>	pico	p
10 <sup>2</sup>	hecto	h	10 <sup>-15</sup>	femto	f
10 <sup>1</sup>	deka	da	10 <sup>-18</sup>	atto	a

The names and symbols listed above are used, in combination with the names and symbols, respectively, of the SI units, as prefixes to form decimal multiples and sub-multiples of those units. (This table is based on Table 7 of [16] to which we have added the two recently adopted<sup>1</sup> prefixes "exa" and "peta" for 10<sup>18</sup> and 10<sup>15</sup>, respectively.)

---

<sup>1</sup>See, for example, NBS Dimensions, Vol. 59, No. 10, October 1975, p. 229.

Table A1-3

## SI Derived Units for Radiometry

Quantity†	Symbol	Definition††	Unit	Unit Symbol
radiant energy	$Q, Q_e$		joule	[J]
radiant (directed-surface) exposure	$H, H_e$	$dQ/dA;$ $\iint L \cdot \cos\theta \cdot d\omega \cdot dt$	joule per square meter	[J·m <sup>-2</sup> ]
radiant (omni-directional) fluence	$F, F_e$	$dQ/da;$ $\iint L \cdot d\omega \cdot dt$	joule per square meter	[J·m <sup>-2</sup> ]
radiant (volume) density	$w, w_e$	$dQ/dV$	joule per cubic meter	[J·m <sup>-3</sup> ]
radiant power or flux	$\phi, \phi_e$	$dQ/dt$	watt	[W]; ([J·s <sup>-1</sup> ])
radiant intensity	$I, I_e$	$d\phi/d\omega$	watt per steradian	[W·sr <sup>-1</sup> ]
radiant flux (directed-surface) density	$W, W_e$	$d\phi/da;$ $\int L \cdot \cos\theta \cdot d\omega$	watt per square meter	[W·m <sup>-2</sup> ]
irradiance	$E, E_e$			
radiant exitance	$M, M_e$			
radiant (omni-directional) fluence rate	$F_t, F_{t,e}, t$	$d\phi/da;$ $\int L \cdot d\omega$	watt per square meter	[W·m <sup>-2</sup> ]
radiance	$L, L_e$	$d^2\phi/(dA \cdot \cos\theta \cdot d\omega);$ $d^2\phi/(da \cdot d\omega)$	watt per square meter and steradian	[W·m <sup>-2</sup> ·sr <sup>-1</sup> ]
radiant steriscent	$L_e^*, L_e$	$dL_g/dx; dI/dV$	watt per cubic meter and steradian	[W·m <sup>-3</sup> ·sr <sup>-1</sup> ]
-----				
spectral radiant energy	$Q_\lambda, Q_{e,\lambda}$	$dQ/d\lambda$	joule per nanometer	[J·nm <sup>-1</sup> ]
spectral radiance	$L_\lambda, L_{e,\lambda}$	$dL/d\lambda$	watt per square meter, steradian, and nanometer	[W·m <sup>-2</sup> ·sr <sup>-1</sup> ·nm <sup>-1</sup> ]

(other spectral quantities are similarly treated)

†All of these quantities are defined and discussed in Chapters 2, 3, and 5.

††All symbols are defined and used elsewhere in this Manual; it is important to distinguish:  $dA$  = element of (directed) surface;  $da$  = cross-sectional area of spherical element;  $dL_g$  = element of generated (emitted or scattered into ray) radiance;  $dx$  = element of distance along ray;  $dV$  = element of volume; and  $dt$  = element of time.

Table A1-4

SI Derived Units for Photometry

<u>Quantity</u>	<u>Symbol</u>	<u>Unit</u>	<u>Unit Symbol</u>
luminous energy	$Q, Q_v$	lumen-second; (candela-steradian-second) lumen-second; (talbot)	[lm·s]; ([cd·sr·s]) [lm·s]
luminous (directed- surface) exposure	$H, H_v$	lux-second (candela-steradian-second-per square meter) lumen-second per square meter	[lx·s] ([cd·sr·s·m <sup>-2</sup> ]) [lm·s·m <sup>-2</sup> ]
luminous (omni-direc- tional) fluence	$F, F_v$	lux-second (candela-steradian-second per square meter) lumen-second per square meter	[lx·s] ([cd·sr·s·m <sup>-2</sup> ]) [lm·s·m <sup>-2</sup> ]
luminous flux	$\phi, \phi_v$	lumen; (candela-steradian) lumen	[lm]; ([cd·sr]) [lm]
luminous intensity	$I, I_v$	candela lumen per steradian	[cd] [lm·sr <sup>-1</sup> ]
luminous flux (directed- surface) density	$W, W_v$	lumen (candela-steradian) per square meter lumen per square meter	[lm·m <sup>-2</sup> ]; ([cd·sr·m <sup>-2</sup> ]) [lm·m <sup>-2</sup> ]
illuminance (illumination)	$E, E_v$	lux; (candela-steradian per square meter) lumen per square meter	[lx]; ([cd·sr·m <sup>-2</sup> ]) [lm·m <sup>-2</sup> ]
luminous exitance	$M, M_v$	lumen (candela-steradian) per square meter lumen per square meter	[lm·m <sup>-2</sup> ]; ([cd·sr·m <sup>-2</sup> ]) [lm·m <sup>-2</sup> ]
luminous (omni-direc- tional) fluence rate	$F_t, F_t, v, t$	lux; (candela-steradian per square meter) lumen per square meter	[lx]; ([cd·sr·m <sup>-2</sup> ]) [lm·m <sup>-2</sup> ]
luminance	$L, L_v$	candela per square meter lumen per square meter and steradian	[cd·m <sup>-2</sup> ] [lm·m <sup>-2</sup> ·sr <sup>-1</sup> ]
luminous steriscent	$L_v^*, L_v^*$	candela per cubic meter lumen per cubic meter and steradian	[cd·m <sup>-3</sup> ] [lm·m <sup>-3</sup> ·sr <sup>-1</sup> ]

NOTE: The first entry or entries for each quantity give the strict SI units, in terms of the candela [cd] as the base unit. The last entry for each quantity is the same unit in terms of the lumen [lm] or lumen-second [lm·s], that parallels the corresponding radiometric unit in terms of the watt [W] or joule [J], respectively, for the corresponding quantity in Table A1-3. The definitions (defining equations) in that Table, and the footnotes there, also apply to the corresponding quantities listed here.

Table A1-5

Some Additional non-SI Photometric Units

<u>Unit</u>	<u>Symbol</u>	<u>SI Equivalent</u>	<u>Quantity</u>
apostilb	[asb]	$= \pi^{-1}[\text{cd}\cdot\text{m}^{-2}]$	luminance
candela-second	[cd·s]	$= 1[\text{cd}\cdot\text{s}]$	ergolumic intensity*
footcandle	[fc] = [lm·ft <sup>-2</sup> ]	$= 10.764[\text{lm}\cdot\text{m}^{-2}]$	illuminance
footlambert	[fL] = $\pi^{-1}[\text{cd}\cdot\text{ft}^{-2}]$	$= 3.426[\text{cd}\cdot\text{m}^{-2}]$	luminance
lambert	[L] = $\pi^{-1}[\text{cd}\cdot\text{cm}^{-2}]$	$= 10^4\cdot\pi^{-1}[\text{cd}\cdot\text{m}^{-2}]$	luminance
light-watt**	[ℓW] = $ K_m^{-1}  \cdot [1\text{m}]$	$\approx 680^{-1}[1\text{m}]$	luminous flux
phot	[ph] = $1[\text{lm}\cdot\text{cm}^{-2}]$	$= 10^4[\text{lm}\cdot\text{m}^{-2}]$	illuminance
stilb	[sb] = $1[\text{cd}\cdot\text{cm}^{-2}]$	$= 10^4[\text{cd}\cdot\text{m}^{-2}]$	luminance

\*The CIE [5] seems not to have any term for this quantity, nor does there seem to be any in general use other than the term for the units, although "beam-candlepower-second" is also used at times. This term for the quantity is taken from Jones' "phluometry" proposal [17].

\*\*The light-watt [ℓW] is related to the unit of radiant flux, the watt [W], by

$$\phi_{\ell} \equiv \int_{380}^{760} V(\lambda) \cdot \phi_{e,\lambda}(\lambda) \cdot d\lambda \quad [\ell\text{W}],$$

where

$V(\lambda)$  [dimensionless] is the photopic spectral luminous efficiency [5,18],

$\lambda$  [nm] is the wavelength,

$\phi_{e,\lambda}(\lambda)$  [ $\text{W}\cdot\text{nm}^{-1}$ ] is a distribution of spectral radiant flux as a function of wavelength, and

$\phi_{\ell}$  [ℓW] is the luminous flux in light-watts of the radiation described by the spectral distribution  $\phi_{e,\lambda}(\lambda)$ .

The luminous flux, in lumens, in this same beam of radiation is given by

$$\phi_v = |K_m| \cdot \phi_{\ell} \approx 680 \cdot \phi_{\ell} \quad [1\text{m}],$$

where

$K_m \approx 680$  [ $\text{lm}\cdot\text{W}^{-1}$ ] at  $\lambda \approx 555$  [nm] is the maximum spectral luminous efficacy (of radiation) [5,18].

Note that both the lumen and the light-watt are units of luminous flux. They have the same dimensionality and differ only by the numerical scale factor  $|K_m| \approx 680$ . There are approximately 680 lumens per light-watt at all wavelengths in the visible region of the spectrum where  $380 \leq \lambda \leq 760$  [nm].



Table A1-6

## Units for Photon-Flux Radiometry

Quantity <sup>†</sup>	Symbol	Unit	Unit Symbol
photon energy	$Q, Q_p$	quantum <sup>††</sup>	[q]
photon exposure	$H, H_p$	quantum per square meter	$[q \cdot m^{-2}]$
photon fluence	$F, F_p$	" "	$[q \cdot m^{-2}]$
photon flux	$\phi, \phi_p$	quantum per second	$[q \cdot s^{-1}]$
photon-flux intensity	$I, I_p$	quantum per second and steradian	$[q \cdot s^{-1} \cdot sr^{-1}]$
photon-flux (surface) density	$W, W_p$		
incident photon-flux density	$E, E_p$	quantum per second and square meter	$[q \cdot s^{-1} \cdot m^{-2}]$
photon-flux exitance	$M, M_p$		
photon-flux fluence rate	$F_t, F_p, t$	quantum per second and square meter	$[q \cdot s^{-1} \cdot m^{-2}]$
photon-flux sterance (radiance)	$L, L_p$	quantum per second, square meter, and steradian	$[q \cdot s^{-1} \cdot m^{-2} \cdot sr^{-1}]$
photon-flux steriscent	$L^*_p, L_p$	quantum per second, cubic meter, and steradian	$[q \cdot s^{-1} \cdot m^{-3} \cdot sr^{-1}]$

<sup>†</sup>Definitions (defining equations) are the same as for corresponding quantities in Table A1-3. Also spectral quantities are formed as shown in that Table.

<sup>††</sup>The number of photons or quanta in a beam of radiation is frequently regarded as a pure (dimensionless) number, the ratio between the energy in that beam and the energy ( $h\nu$ ) of an individual photon or quantum. However, that number is certainly a measure of the "amount of radiation" in the beam and it is not just a number, but is a number of a distinctive physical quantity, just as the number of joules is a physical quantity. Accordingly, it is useful to assign the quantum per second  $[q \cdot s^{-1}]$  as the unit of photon flux. Then all of the other geometrical quantities and their interrelationships and units parallel exactly those for radiant flux, luminous flux, or any other flux of a physical quantity propagated in rays that obey the laws of geometrical optics.

NOTE: the einstein  $[E] = N_A \cdot [q]$  (where  $N_A$  is the Avogadro constant, the number of molecules (particles) per mole [mol] of any substance), is widely used as a (much larger) unit of photon flux. {The latest value of the Avogadro constant in NBS Spec. Pub. 398 (Aug. 1974) is given as

$$N_A = (6.022045 \pm 0.000031) \times 10^{23} \text{ [particles} \cdot \text{mol}^{-1}\text{].}$$

Appendix 2. Spherical Coordinates and Geometrical Relationships

SPHERICAL COORDINATES (solid polar coordinates). In almost all optical radiation measurement situations, we are concerned with the flux through a reference surface that intersects a beam of radiation. We need coordinates for specifying, at each point of that reference surface, the direction of every intersecting ray incident from (or exitent into) the entire hemisphere above the plane tangent to the reference surface at that point. That is the plane containing the element of surface  $dA$  at the given point. The most useful coordinate system for this purpose is illustrated in figure A2-1. The given point  $O$  is taken as the origin. The normal to  $dA$  at  $O$  is chosen as the polar axis for spherical coordinates or the  $Z$ -axis for rectangular coordinates. The tangent plane, containing the element  $dA$ , is then the  $X$ - $Y$  plane. A straight line extending from  $O$  in some convenient direction in that plane is selected as the azimuth reference or  $X$ -axis. The spherical coordinates of any point  $P$  in space, as shown in the figure, are then  $\rho, \theta, \phi$ , where  $\rho$  is the length of the line  $OP$ ,  $\theta$  is the polar angle between the line  $OP$  and the polar axis, and  $\phi$  is the azimuth angle in the tangent plane between  $OP'$ , the projection of  $OP$  on that plane, and the azimuth reference (the  $X$ -axis). The corresponding rectangular coordinates of  $P$  are  $x, y, z$ , where

$$\left. \begin{aligned} x &= \rho \cdot \sin\theta \cdot \cos\phi, \\ y &= \rho \cdot \sin\theta \cdot \sin\phi, \text{ and} \\ z &= \rho \cdot \cos\theta, \end{aligned} \right\} \text{(A2-1)}$$

so that

$$\left. \begin{aligned} \rho &= (x^2 + y^2 + z^2)^{\frac{1}{2}}, \\ \theta &= \tan^{-1}[(x^2 + y^2)^{\frac{1}{2}}/z], \text{ and} \\ \phi &= \tan^{-1}(y/x). \end{aligned} \right\} \text{(A2-2)}$$

Usually, we are concerned only with the direction of a ray rather than the coordinates of a particular point on the ray. The direction of the ray through  $O$  and  $P$  is specified by just the two angles  $\theta, \phi$ . Also, when they are often confined to the hemisphere above the tangent plane,  $0 \leq \theta \leq \pi/2$  [rad] and  $0 \leq \phi \leq 2\pi$  [rad].

A SOLID ANGLE. One of the best ways to grasp the concept of a solid angle is by analogy with the corresponding features of the more familiar plane angle. Accordingly, we'll start with a brief look at plane angles.

A plane angle, formed by two straight lines that meet at a point, the vertex, is defined as the locus of all directions that may be occupied by either line as it is rotated about the vertex to bring it into directional coincidence with the other line. For example, in figure A2-2, the lines  $OA$  and  $OB$  form the angle  $\theta$  at the vertex  $O$ . That is the angle filled by all of the intermediate positions that could be occupied by either line as it is rotated about  $O$  to bring it into coincidence with the direction of the other line. Note that the acute angle  $\theta$ , as shown, is covered by the most direct sense for such rotation. However, these lines also define an exterior obtuse angle of  $(360 - \theta)$  [deg]

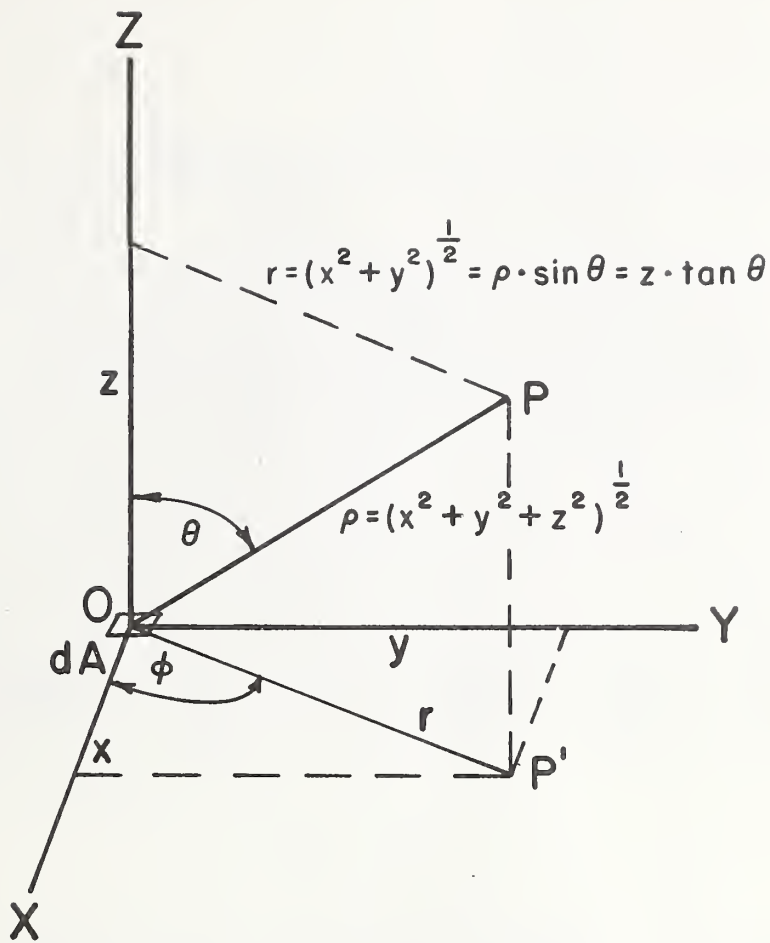

Figure A2-1. Spherical and rectangular coordinates of  $P(\rho, \theta, \phi) = P(x, y, z)$

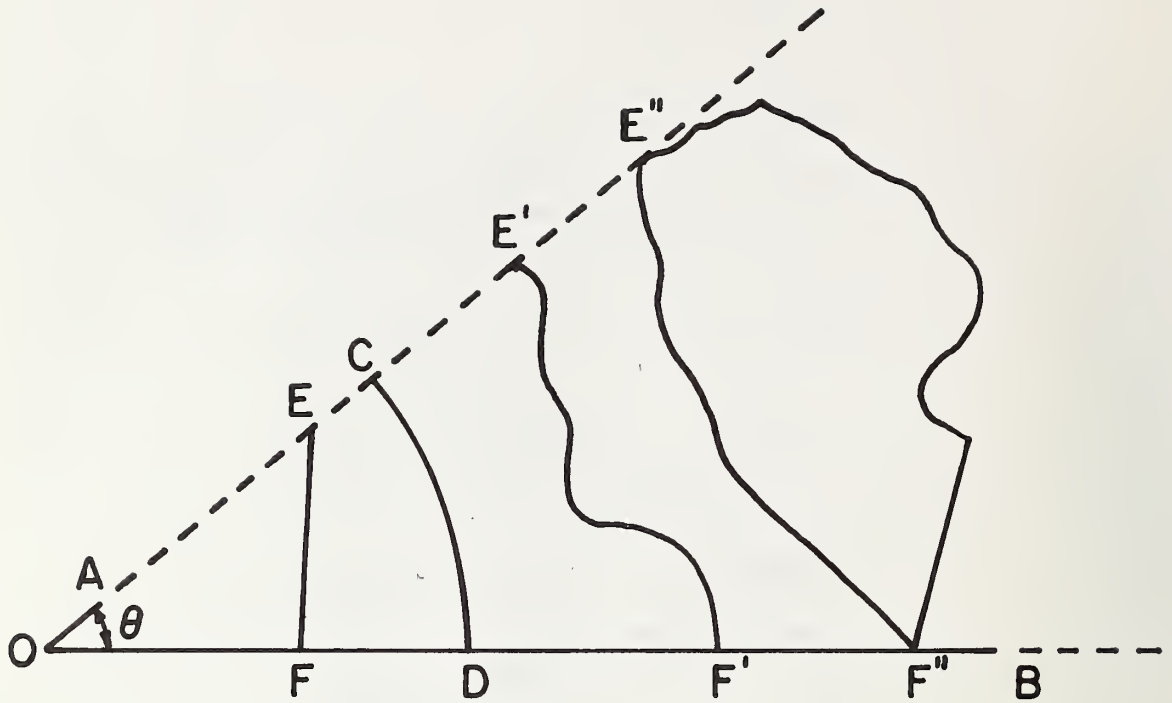

Figure A2-2. The same plane angle  $\theta$  is subtended at  $O$  by:

1. the circular arc  $CD$ ,
2. the straight line  $EF$ ,
3. the curve  $E'F'$ ,
4. the plane figure  $E''F''$ .

or  $(2\pi - \theta)$  [rad] if the rotation is in the opposite sense [the units are defined in the next paragraph].

The length of each line is immaterial, just so it's long enough to be a straight-line segment. In fact, an angle is also formed when two curved lines meet if it's possible to draw the tangent to each curve at the point of intersection, the vertex. The angle between the curves is then the angle between the tangents. Hence, it is also the angle between the infinitesimal elements of the curved lines at that point. In figure A2-2, the lower straight line OB intersects a transverse straight line at F, a circular arc at D, an irregular curve at F', and the extreme point of a plane figure at F''. The upper straight line OA is too short to meet any of these same lines or the plane figure, but its extension intersects the lines at E, C, and E', respectively, and is tangent to the plane figure at its other extremity at E''. Then we can say that the angle  $\theta$  intercepts the line segments EF, CD, and E'F' and just encloses or contains the plane figure E''F''. Conversely, the line segments and the plane figure all subtend the same angle  $\theta$  at O. In particular, the circular arc CD has its center at O, so its length is a measure of the angle  $\theta$ . In radians [rad], the size of the angle is given by the ratio of the length of the arc CD to its radius OC or OD:

$$\theta = CD/OC \text{ [rad]}. \quad (\text{A2-3})$$

The magnitude of the same angle in (circular) degrees [deg] is given by

$$\theta = (180/\pi) \cdot (CD/OC) \text{ [deg]}. \quad (\text{A2-4})$$

A solid angle is similarly formed at a point, also called the vertex, by a conical surface or cone. The cone, in turn, is the surface that contains all possible straight lines (i.e., is the locus of those lines) that extend from the vertex point to a point on some closed, simply-connected curve in space that does not pass through the vertex. Such a "curve," using the term in its broadest sense, may include straight-line segments and discontinuous changes of direction or angles. It is only required that, starting from any point on the "curve" and traveling along it far enough in either direction, you return to the starting point after passing once, and only once, through every other point on the "curve." In particular, when the "curve" is made up entirely of straight-line segments that form a polygon, the "cone" is a pyramid. On the other hand, when a pencil of rays converges on the axis of a cylindrical optical system, with circular optical components, the solid angle formed at the focus is bounded by a right circular cone and a solid angle is very often so depicted. In fact, speaking loosely, we often say that the solid angle is a right circular cone. However, there is really no such limitation on the concept of a solid angle which, as we have just seen, can be formed at the vertex of a pyramid, or of the conical surface formed by the straight lines joining the vertex to a closed curve of almost any shape (see figure A2-3).

Like a plane angle, a solid angle can be defined as a locus of directions; it is the

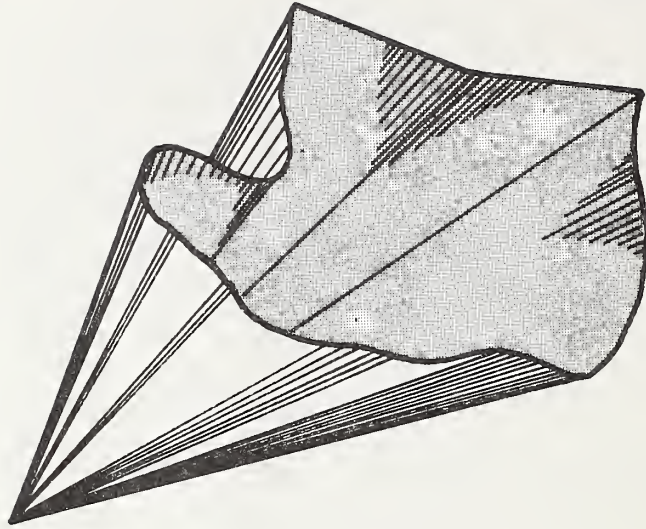

Figure A2-3. A solid angle.

locus of all directions lying within the defining cone. Also, just as with a plane angle, there are always two possibilities: the acute interior solid angle and the obtuse exterior solid angle. However, unless the contrary is stated, it is usually assumed to be the acute interior solid angle.

Any plane through the vertex of a solid angle that intersects the cone enclosing the solid angle will do so along two straight lines that meet at the vertex to form a plane angle. Thus, we can consider figure A2-2 as depicting such an intersection with a solid angle having its vertex at  $O$  and with the points  $A$  and  $B$  lying on the closed curve in space that defines the bounding cone and, accordingly, does not pass through  $O$ . Then the straight-line segment  $EF$  represents a plane area, the arc  $CD$  a spherical-surface area, the line segment  $E'F'$  an irregular surface area, and the plane figure  $E''F''$  a section through an irregular solid object, all of which subtend the same solid angle  $\omega$  at  $O$ .

The measure of a solid angle is sometimes confused with the solid angle itself. The solid angle is that which exists at the vertex, regardless of the extent of the bounding conical surface, just as a plane angle can be formed at a vertex by very short straight-line segments, or even infinitesimal line elements. The *measure* of the solid angle, on the other hand, is provided by the area intercepted by the bounding cone, or its extension beyond the defining curve if necessary, on the surface of a sphere centered at the vertex, just as the plane angle is measured by the intercepted arc of a circle centered at its vertex. The magnitude of a solid angle  $\omega$  in steradians [sr] is just the ratio of this intercepted spherical-surface area  $A_s$  to the square of the radius  $\rho$  of the sphere:

$$\omega = A_s / \rho^2 \text{ [sr]}. \quad (\text{A2-5})$$

A SOLID ANGLE in SPHERICAL COORDINATES. To express a solid angle  $\omega$  in spherical coordinates, we will start, first, with just an element of solid angle  $d\omega$ . In figure A2-4, we show the angle  $\theta$  increased by an infinitesimal element  $d\theta$  and the angle  $\phi$  similarly increased by  $d\phi$ . The point  $P$ , always at the same distance  $\rho$  from the origin  $O$ , moves over the surface of a sphere of radius  $\rho$ . The element of angle  $d\theta$  intercepts an arc of length  $\rho \cdot d\theta$  on the spherical surface. The element  $d\phi$ , however, represents rotation about the polar or  $Z$ -axis. Hence, the point  $P$  does not move on a great circle. Instead, it follows an element of arc of radius  $\rho \cdot \sin\theta$  (the projection of  $OP$ , of length  $\rho$ , onto the  $X$ - $Y$  plane, or onto a plane parallel to the  $X$ - $Y$  plane through  $P$ ). The length of that circular arc on the spherical surface is  $\rho \cdot \sin\theta \cdot d\phi$ , and it subtends an element of angle  $\sin\theta \cdot d\phi$  [rad] at the origin  $O$ . Two pairs of these elements of arc enclose the element of spherical-surface area  $dA_s = \rho^2 \cdot \sin\theta \cdot d\theta \cdot d\phi$ , as shown in the figure. The element of solid angle  $d\omega$ , subtended at the origin  $O$  by that area element  $dA_s$  is, by eq. (A2-5),

$$d\omega = dA_s / \rho^2 = \sin\theta \cdot d\theta \cdot d\phi \text{ [sr]}. \quad (\text{A2-6})$$

It is also clear, since each of the angle elements  $d\theta$  and  $\sin\theta \cdot d\phi$  is in units of radians [rad], that their product is in units of square radians [rad<sup>2</sup>], just as the

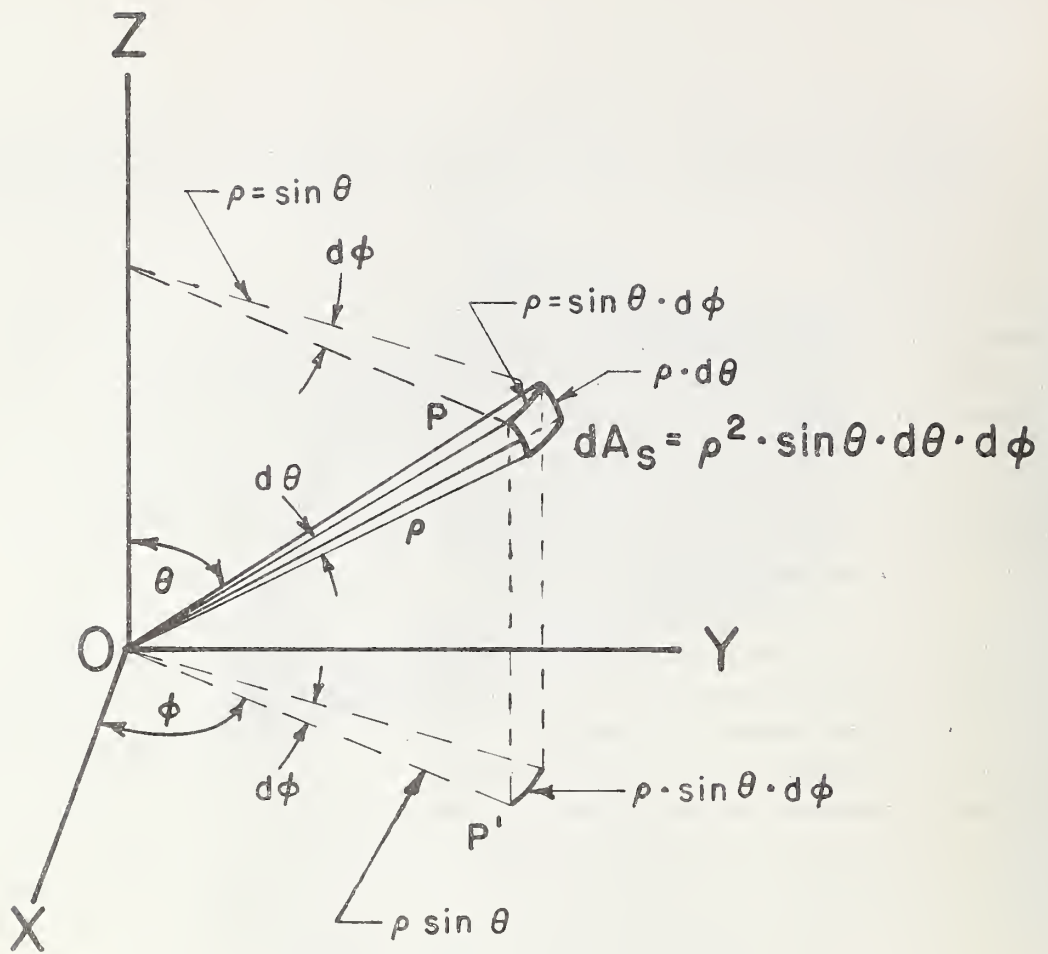

Figure A2-4. An element of solid angle

$$d\omega = dA_s / \rho^2 = \sin\theta \cdot d\theta \cdot d\phi$$



corresponding arc lengths  $\rho \cdot d\theta$  and  $\rho \cdot \sin\theta \cdot d\phi$ , each in meters [m], have a product  $dA_s = \rho^2 \cdot \sin\theta \cdot d\theta \cdot d\phi$  that is an area in square meters [m<sup>2</sup>]. Thus, a steradian [sr] is a square radian [rad<sup>2</sup>].

Although the relationship between radians and degrees, as plane-angle units, is familiar enough so that most people feel they understand it, there is confusion about their dimensions. In the case of a solid angle, similar confusion exists concerning dimensions and, furthermore, concerning the relationship between steradians and square degrees. Moon and Spencer [19] have made a helpful suggestion, that we recognize the orthogonality of direction between radial lengths and transverse lengths by designating their dimensions as  $[L_r]$  and  $[L_t]$ , respectively. Then a plane angle has the dimensions  $[L_t \cdot L_r^{-1}]$  rather than being a dimensionless ratio as in the usual treatment. The distinction may not seem too important when the same length units are used for both the arc and the radius to evaluate the size of an angle in radians as the quotient of these two quantities. However, if we measure the arc in smaller units, equal to  $\pi/180 \approx 1.745\,329 \times 10^{-2}$  times the length unit for the radius, the quotient will be the size of the same angle in degrees. Carrying this one step further, we can now relate the unit of solid angle, the steradian or square radian, to the square degree quite simply through this same relationship, since we have established the equivalence of a steradian and a square radian.

$$1[\text{deg}] = (\pi/180)[\text{rad}] \approx 1.745\,329 \times 10^{-2}[\text{rad}] \quad (\text{A2-7})$$

$$\begin{aligned} 1[\text{deg}^2] &= (\pi/180)^2[\text{rad}^2] = (\pi/180)^2[\text{sr}] \\ &\approx 3.046\,174 \times 10^{-4}[\text{sr}]. \end{aligned} \quad (\text{A2-8})$$

Incidentally, the usefulness and validity of the treatment based on the suggestion by Moon and Spencer is well brought out by the way in which it clarifies the confusion about the dimensions of work or energy and of torque or moment, something that bothers almost every physics student when first introduced to dimensional analysis. In the notation used above, work or energy has the dimensions of force times colinear length--either  $[F_r \cdot L_r]$  or  $[F_t \cdot L_t]$ --while torque or moment has the dimensions of force times orthogonal length--usually  $[F_t \cdot L_r]$ . But work or energy is generated when a torque or moment acts through a plane angle. Dimensionally, that situation is described by  $[f_t \cdot L_r] \cdot [L_t \cdot L_r^{-1}] = [F_t \cdot L_t]$ , which is gratifyingly self-consistent.

So much for the digression into units and dimensions. We obtained the expression for the element of solid angle in spherical coordinates in eq. (A2-6). The integral of that quantity over the appropriate limits then provides us with a general expression for any solid angle in spherical coordinates:

$$\omega = \int_{\phi} \int_{\theta} \sin\theta \cdot d\theta \cdot d\phi \quad [\text{sr}]. \quad (\text{A2-9})$$

For example, it is often useful to have the expression for the solid angle at the vertex of a right circular cone of half-vertex angle  $\theta_h$ . If we choose the polar axis along the axis

of the cone and the origin at the vertex, as in figure A2-5, it is easy to see that

$$\omega = \int_0^{2\pi} \int_0^{\theta_h} \sin\theta \cdot d\theta \cdot d\phi = 2\pi(1 - \cos\theta_h) = 4\pi \cdot \sin^2(\theta_h/2) \text{ [sr]}. \quad (\text{A2-10})$$

For a hemisphere,  $\theta_h = \pi/2$  [rad],  $\cos\theta_h = 0$ , and  $\sin(\theta_h/2) = 1/\sqrt{2}$ , so that

$$\omega_{\text{hemisphere}} = 2\pi \text{ [sr]} \approx 2.062\,648 \times 10^4 \text{ [deg}^2\text{]} \quad (\text{A2-11})$$

and

$$\omega_{\text{sphere}} = 4\pi \text{ [sr]} \approx 4.125\,296 \times 10^4 \text{ [deg}^2\text{]}. \quad (\text{A2-12})$$

Finally, we want a general expression for the element of solid angle  $d\omega_{12}$  [sr] subtended at a surface element  $dA_1$  by an arbitrarily oriented surface element  $dA_2$  [m<sup>2</sup>] at a distance of  $D$  [m]. This situation is illustrated in figure A2-6, where  $dA_2$  is shown with its normal making an angle  $\theta_2$  with the line joining the two area elements. It is evident in the figure that the solid-angle element  $d\omega_{12}$  subtended at  $dA_1$  by  $dA_2$  intercepts an area element  $dA_2 \cdot \cos\theta_2$  on the surface of a sphere of radius  $D$  about  $dA_1$ . Then, from eq. (A2-5), we can write immediately

$$d\omega_{12} = (dA_2 \cdot \cos\theta_2)/D^2 \text{ [sr]}. \quad (\text{A2-13})$$

Up to this point, we have considered only the simplest form of solid angle where the cone enclosing the angle is determined by a simply-connected curve. However, two or more such simple solid angles can be combined in various ways to produce much more complicated angles. For example, as illustrated in figure A2-7, the solid angle filled by converging rays at the focus of a Cassegrain-type optical system is a "hollow" cone. There are converging rays only within the solid angle between two coaxial right circular cones; there are none within the smaller inner cone.

A PROJECTED SOLID ANGLE. In Chapter 2, we defined radiance in eq. (2.14) in terms of the element of flux through an element of projected area  $\cos\theta \cdot dA$  and an element of solid angle  $d\omega$ . There, the obliquity factor  $\cos\theta$  is clearly associated with the element of area  $dA$ . However, when we obtain from this definition the expression for the flux in an entire beam, eq. (2.25), particularly in the case of uniform isotropic radiation, with constant  $L$  throughout the beam, and no vignetting so that the integrals are separable, as in eq. (2.30), it is convenient to associate the obliquity factor  $\cos\theta$ , instead, with the element of solid angle  $d\omega$  as  $\cos\theta \cdot d\omega = \cos\theta \cdot \sin\theta \cdot d\theta \cdot d\phi$ . We have followed Jones [16] in calling

$$\Omega \equiv \int_{\omega} d\Omega \equiv \int_{\omega} \cos\theta \cdot d\omega \text{ [sr]} \quad (\text{2.31a})$$

the projected solid angle associated with the solid angle  $\omega$ . It is a weighted solid angle (and is sometimes so-called), with the obliquity factor  $\cos\theta$  as the weighting function.

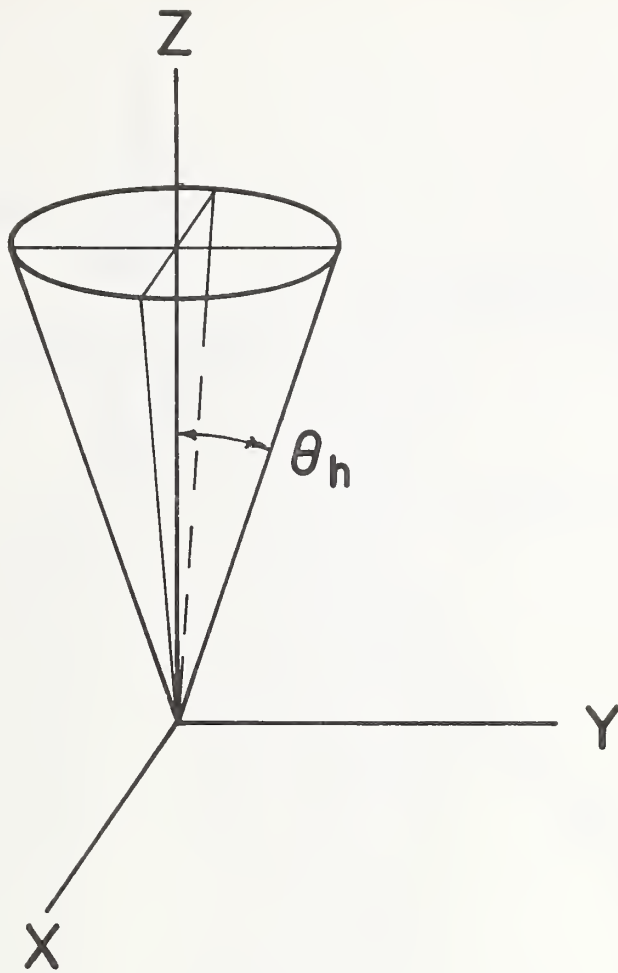

Figure A2-5. A right circular cone about the polar axis, with half-vertex angle  $\theta_h$ .

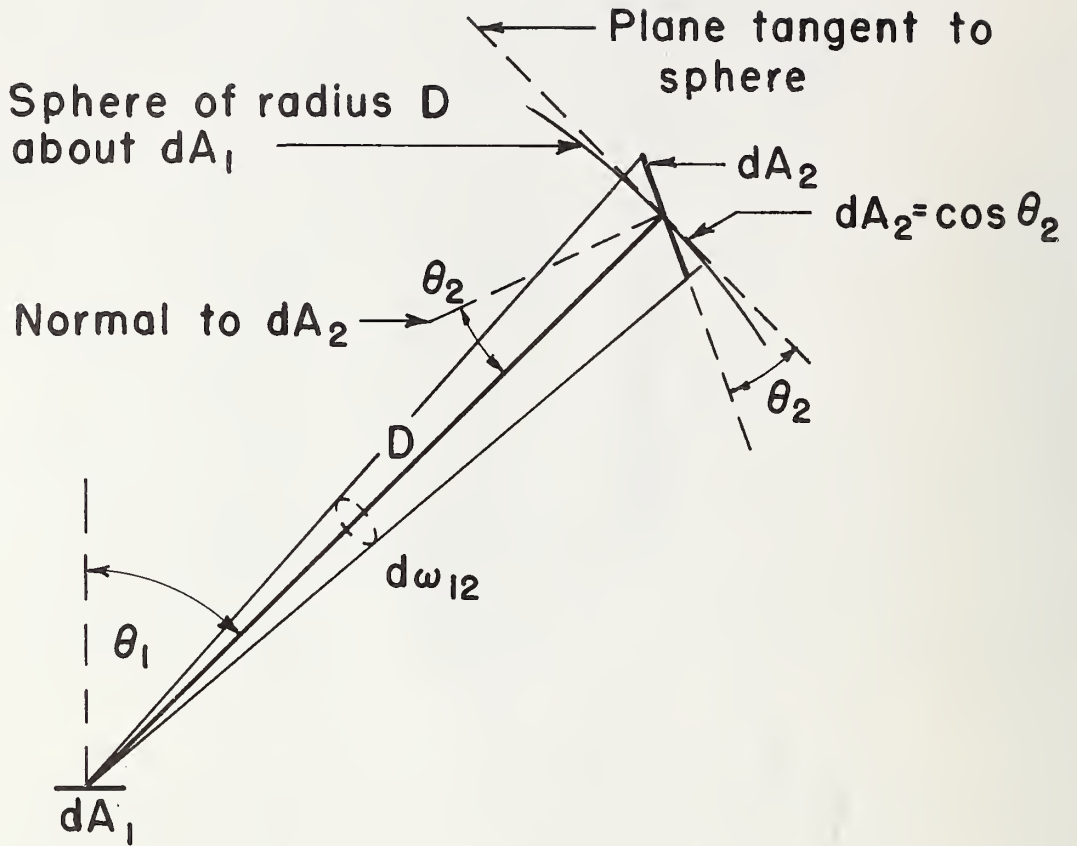

Figure A2-6. An arbitrarily oriented surface element  $dA_2$  subtends a solid-angle element  $d\omega_{12}$  at  $dA_1$  at a distance  $D$ .

$$d\omega_{12} = (dA_2 \cdot \cos \theta_2) / D^2 \text{ [sr]}.$$

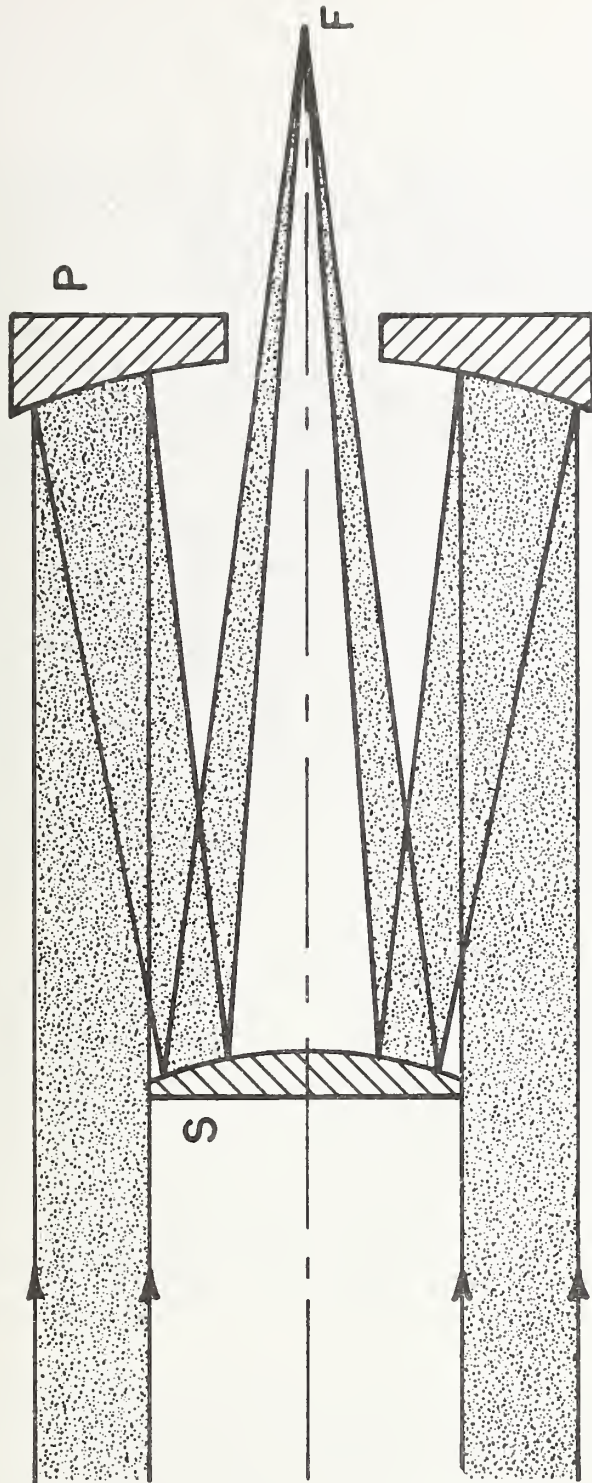

Figure A2-7. Sketch of Cassegrain-type optics. Incident parallel rays converge at the focus F. Because some incident rays are blocked by the secondary mirror S, the solid angle of the converging rays at F is a "hollow" cone, with no rays in the coaxial inner cone.

The name is suggested by the analogy with an element of projected area  $\cos\theta \cdot dA$ . However, while the projection of an area onto another surface can be constructed so that there exists an area that *is* the projected area, don't try to picture or visualize anything similar for the projected solid angle. It doesn't exist in that sense, although there are at least two geometrical constructions for the *measure* of a projected solid angle that can be very helpful.

The first of these has been called Nusselt's construction [20] by Jakob [21], who also cites Seibert [22] who published in the same year as Nusselt [20]. However, Gershun [23] cites a much earlier publication by Wiener [24]. This, incidentally, is a good illustration of how badly scattered and disjointed things can be in the literature on optical radiation measurements. Wiener's construction is presented in figures A2-8 and A2-9. In figure A2-8, a hemisphere of unit radius above a surface element  $dA$  is shown both in vertical elevation and in horizontal plan view. An element of spherical-surface area on this hemisphere is labelled  $d\omega$  because its area is equal to the element of solid angle  $d\omega$  [sr] that it subtends at  $dA$  at the center of the hemisphere. The rectilinear projection of that spherical-surface area element onto the circular base of the hemisphere in the tangent plane containing  $dA$  is, in turn, labelled  $d\Omega = \cos\theta \cdot d\omega$  [sr], its area being equal to the projected solid angle in steradians. The sides of that element of projected area on the base are also shown to be  $\cos\theta \cdot d\theta$  [rad] radially and  $\sin\theta \cdot d\phi$  [rad] in the orthogonal direction.

Figure A2-9 shows, similarly, how the conical projection of an irregular object onto the surface of the unit-radius hemisphere is equal in total area to the solid angle  $\omega$ , in steradians, subtended by that object at  $dA$  at the center of the hemisphere. Also, since the relationship shown in figure A2-8 holds for every element  $d\omega$  of the entire spherical-surface area  $\omega$ , the rectilinear projection of that entire area onto the base of the hemisphere is equal in area to the total projected solid angle  $\Omega \equiv \int_{\omega} \cos\theta \cdot d\omega$  in steradians subtended at  $dA$  by this same object. In fact, the relationship holds for the complete hemisphere of  $2\pi$  [sr] solid angle (the area of the unit-radius hemispherical surface). The corresponding projected solid angle in steradians is equal to the area of the projection of the hemisphere onto the plane of  $dA$  -- the full unit-radius circular base -- which is  $\pi$  [sr].

We can verify that last result analytically. First, we need the general expression for the projected solid angle at the vertex of a right circular cone of half-vertex angle  $\theta_h$  with its axis normal to  $dA$ . Again, as in figure A2-5, we choose the polar axis along the axis of the cone and the origin at the vertex to write for the projected solid angle

$$\begin{aligned} \Omega &= \int_0^{2\pi} \int_0^{\theta_h} \cos\theta \cdot \sin\theta \cdot d\theta \cdot d\phi = (\pi/2) \cdot (1 - \cos 2\theta_h) \\ &= \pi \cdot \sin^2 \theta_h \text{ [sr]}. \end{aligned} \tag{A2-14}$$

For the full hemisphere,  $\theta_h = \pi/2$  [rad],  $\cos 2\theta_h = -1$ , and  $\sin \theta_h = 1$ ,

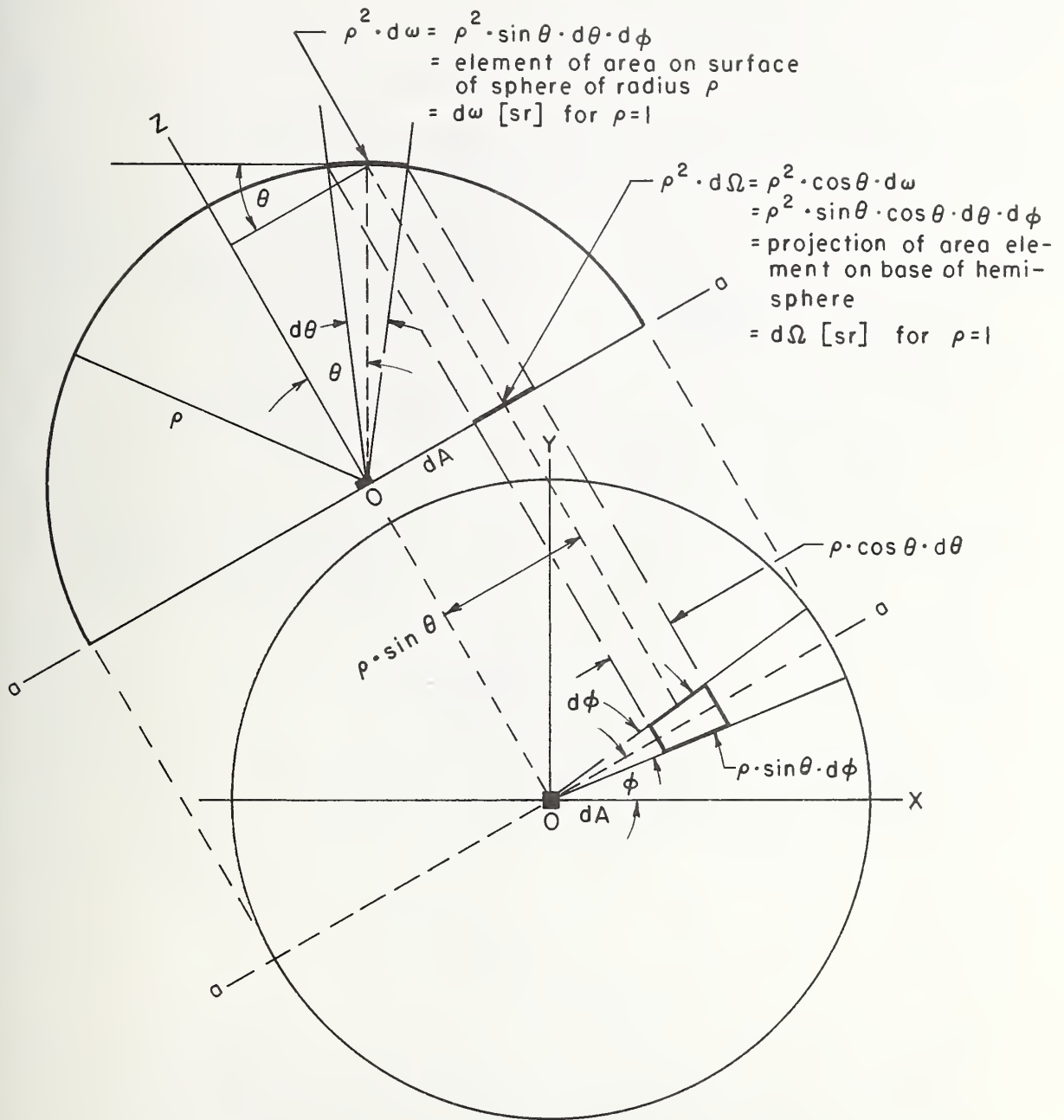

Figure A2-8. Geometrical construction for measures of an element of solid angle  $d\omega$  and an element of projected solid angle  $d\Omega$ .

$$d\omega \equiv \sin\theta \cdot d\theta \cdot d\phi; \quad d\Omega \equiv \cos\theta \cdot d\omega \equiv \cos\theta \cdot \sin\theta \cdot d\theta \cdot d\phi$$

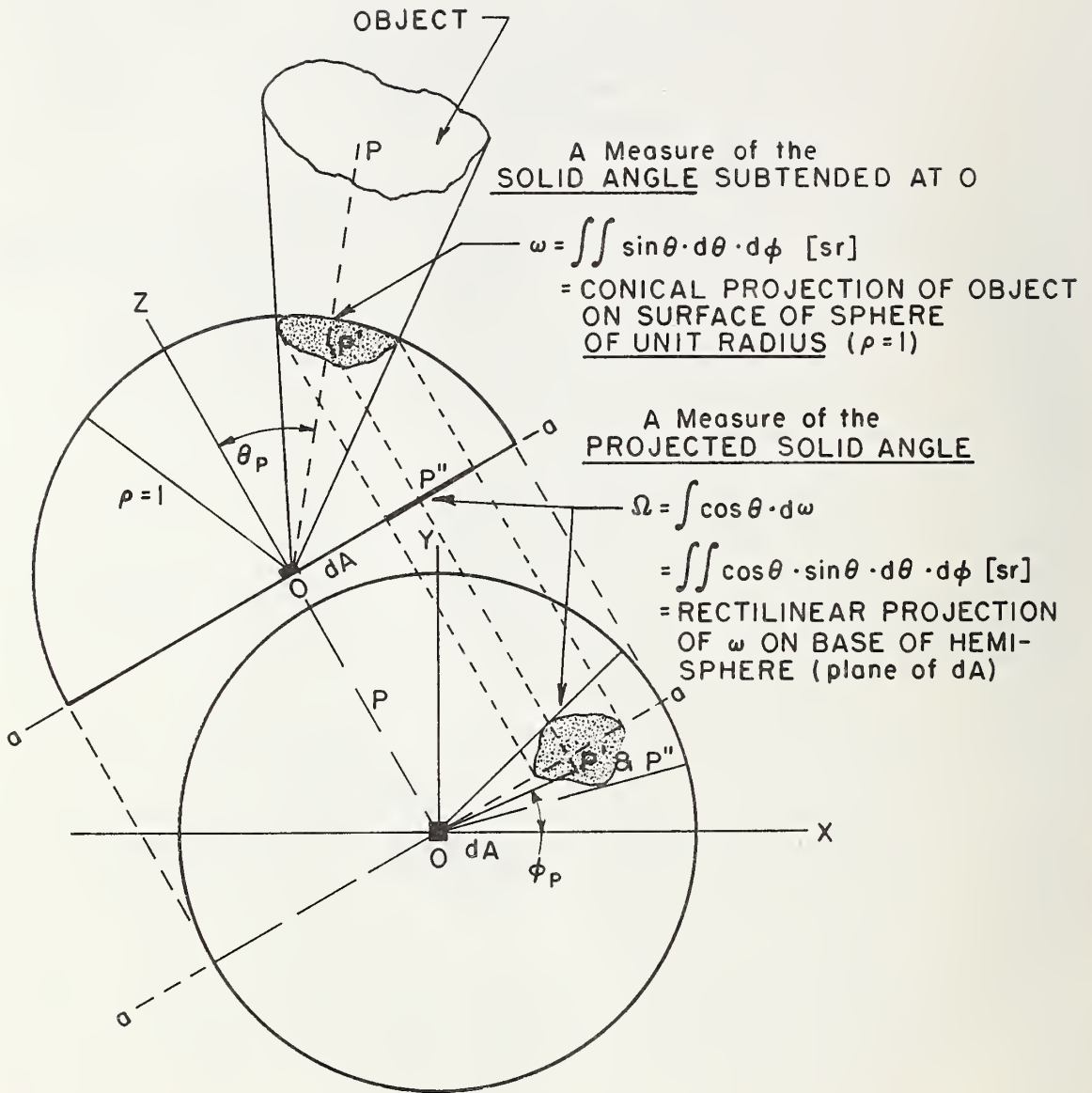

Figure A2-9. Wiener's construction for measures of the solid angle  $\omega$  and the projected solid angle  $\Omega$  subtended at dA by an irregular object. P is an arbitrarily chosen point on the object; P' is its projection (conical) on the unit-radius hemisphere above dA; and P'' is the projection (rectilinear) of P' on the base of the hemisphere (plane of dA).



so that

$$\Omega_{\text{hemisphere}} = \pi [\text{sr}] \approx 1.031\,324 \times 10^4 [\text{deg}^2], \quad (\text{A2-15})$$

in agreement with the conclusion from Wiener's construction.

Wiener's construction provides valuable insight into the relationships between solid angles and the corresponding projected solid angles and facilitates analytical computations. It has also been the basis for analog computers to evaluate projected solid angles or the related configuration factors (angle factors, view factors, etc.) in illumination and heat-transfer engineering [25]. (The relationships between projected solid angles, throughputs, and configuration factors, etc., are discussed in Appendix 3<sup>1</sup>.) A second construction, while not as useful for computations, may seem somewhat more satisfying and mathematically elegant, since it involves an area intercepted by the cone of the solid angle itself rather than a second projection, as in Wiener's construction.

The unit-diameter tangent sphere construction is illustrated in figure A2-10. A unit-diameter sphere is constructed tangent to the surface element  $dA$  at the origin  $O$ . Its center  $C$ , accordingly, lies on the normal to  $dA$  (the polar axis) midway between  $dA$  and the point where the unit-diameter sphere is also tangent to the unit-radius hemisphere about  $O$ . The elementary cone, subtended at  $O$  by a remote surface element  $dS$  at  $P$ , intercepts an element of area  $d\omega$  [ $\rho^2 \cdot d\omega$ , where  $\rho = 1$ ] on the surface of the unit-radius hemisphere at  $P'$ , as before. It also intercepts an area  $da = d\omega \cdot \cos\theta = d\Omega$  at  $P''$  on the surface of the unit-diameter sphere [ $da = 4r^2 \cdot \cos\theta \cdot d\omega$ , where  $r = 1/2$ ], an area that is numerically equal to the subtended projected solid angle. This relationship holds true for every element of solid angle in the entire hemisphere above  $dA$ , so it is also true for the integrated total projected solid angle subtended at  $dA$  by a more extended body or surface. Again, we can verify its validity for the projected solid angle of the entire hemisphere. This would be numerically equal, in steradians, to the total surface area of the unit-diameter sphere:

$$\begin{aligned} \Omega_{\text{hemisphere}} &= 4\pi r^2 \quad \text{for } r = 1/2 \\ &= \pi [\text{sr}]. \end{aligned} \quad (\text{A2-15a})$$

The unit-diameter tangent sphere construction is based on some relations that appear to have been first worked out by Sumpner [26] and have been summarized, more recently and accessibly, by Nicodemus [27]. This construction is used or referred to in a number of texts and papers on illumination and heat-transfer engineering as something that is rather widely known and we have not succeeded in finding any citations or references that help to establish who first devised and published it.

OTHER SOLID-ANGLE MEASURES and/or APPROXIMATIONS. There are two commonly used measures of a solid angle or projected solid angle, when it represents the "light-gathering power" of

---

<sup>1</sup>Appendix 3 will appear in a subsequent Technical Note along with Chapter 4.

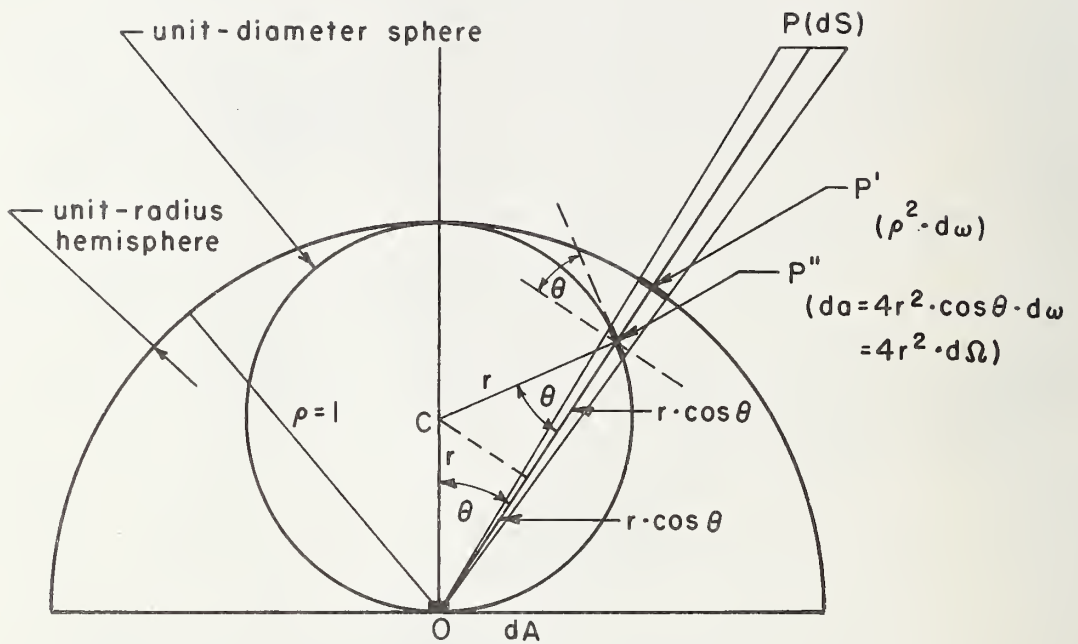

Figure A2-10. Measures of an element of solid angle  $d\omega$  and an element of projected solid angle  $d\Omega$  (unit-diameter tangent sphere construction).

$$d\omega = \sin\theta \cdot d\theta \cdot d\phi = \cos\theta \cdot da / (2r \cdot \cos\theta)^2 = da / (4r^2 \cdot \cos\theta).$$

If  $r = 1/2$  and  $\rho = 2r = 1$ , then

$$da = \cos\theta \cdot d\omega = d\Omega.$$

an optical system or, more exactly, the solid angle or projected solid angle subtended at the focus by the converging pencil of rays. That pencil is contained within the cone subtended by the edges of the exit pupil, usually a right circular cone. For such a cone of half-vertex angle  $\theta_h$ , the two quantities are:

1. the numerical aperture:  $N.A. \equiv n \cdot \sin \theta_h$  [dimensionless], (A2-16)  
where  $n$  is the refractive index of the medium, and

2. the relative aperture or f-number:

$$f/\# \equiv (2 \cdot \sin \theta_h)^{-1} \text{ [dimensionless]}. \quad (\text{A2-17})$$

The popular definition of f-number as the (effective) focal length of a lens divided by its diameter would lead to the approximation  $f/\# \approx (2 \cdot \tan \theta_h)^{-1}$ . However, in well-corrected optical systems (that satisfy Abbe's sine condition [14,28]), the height  $h$  of an incident axial ray above the axis is given by  $h = f \cdot \sin \theta$ , where  $f$  is the effective focal length and  $\theta$  the angle the ray makes with the axis at the focus. Then for the extreme ray,  $f/\# = f/2h = (2 \cdot \sin \theta_h)^{-1}$  for the maximum value of  $h$  and the corresponding  $\theta = \theta_h$ . These two measures are related to the projected solid angle as follows:

$$\Omega = \pi \cdot \sin^2 \theta_h = \pi \cdot [4(f/\#)^2]^{-1} = \pi \cdot (N.A.)^2 \cdot n^{-2} \text{ [sr]}. \quad (\text{A2-18})$$

A common approximation to a solid angle  $\omega$  or a projected solid angle  $\Omega$ , with reference to the angular field of an optical system, is the area of the field stop or exit window in the focal plane divided by the square of the focal distance, which reduces to  $\Omega \approx \pi \cdot \tan^2 \theta_h$  [sr] in terms of the half-field angle  $\theta_h$  [rad]. Another approximation is to express the solid angle, or projected solid angle, as  $\pi \cdot \theta_h^2$  [sr]. When  $\theta_h$  is given in degrees, rather than radians, this last approximation also yields a value in square degrees.

Table A2-1 lists the values of each of the foregoing measures or approximations along with the corresponding values of projected solid angle  $\Omega$  [sr] for the same values of half-vertex angle  $\theta_h$  over the range  $0 \leq \theta_h \leq \pi/2$  [rad] or  $0 \leq \theta_h \leq 90$  [deg]. The percentage of each approximation with respect to the projected solid angle  $\Omega$  is also given.

The range of validity of a particular approximation can be estimated from the table, or it can be evaluated directly. For example, to establish the range for using the approximation  $\Omega \approx \pi \cdot \theta_h^2$  without exceeding a given error of, say one per cent, set

$$\Omega - \pi \cdot \theta_h^2 = -0.01 \cdot \Omega \quad \text{or} \quad \pi \cdot \theta_h^2 = (1.01) \cdot \Omega = (1.01) \cdot \pi \cdot \sin^2 \theta_h,$$

hence 
$$\theta_h = (1.01)^{\frac{1}{2}} \cdot \sin \theta_h = (1.004987562) \cdot \sin \theta_h,$$

so that 
$$\theta_h = 0.1727 \text{ [rad]} = 9.895 \text{ [deg]}.$$

Accordingly, rounding off conservatively, the approximation  $\Omega \approx \pi \cdot \theta_h^2$  will be accurate within one per cent for  $\theta_h \leq 0.172$  [rad] or  $\theta_h \leq 9.89$  [deg].

Table A2-1. Values of projected solid angle  $\Omega$ , solid angle  $\omega$ , common approximations  $\pi \tan^2 \theta_h$  and  $\pi \theta_h^2$ , and related measures of "light-gathering power" ( $f$ -number or relative aperture  $f/\#$ , and numerical aperture N.A.) for right circular cones of half-vertex (polar) angle  $\theta_h$ , about the normal to a reference surface (aperture stop, field stop, etc.), i.e., about the optic axis of a cylindrically symmetric optical system.

$\theta_h$ [degree]	$\theta_h$ [rad]	$\Omega$ ( $\pi \sin^2 \theta_h$ ) [sr]	$\omega$ $2\pi(1 - \cos \theta_h)$ [sr]	Percent of $\Omega^*$ ( $\omega/\Omega$ ) x 100 [percent]	$\pi \tan^2 \theta_h$ [sr]	Percent of $\Omega^*$ [percent]	$\pi \theta_h^2$ [sr]	Percent of $\Omega^*$ [percent]	$f/\#$ ( $2 \sin \theta_h$ ) <sup>-1</sup> [num.]	(N.A.)/( $n^{**}$ ) ( $\sin \theta_h$ ) [num.]
0.573	0.01000	0.000314	0.000314	100.0	0.000314	100.0	0.000314	100.0	50.00	0.01000
1.000	0.01745	0.000957	0.000957	100.0	0.000957	100.0	0.000957	100.0	28.65	0.01745
1.146	0.02000	0.001256	0.001257	100.1	0.001257	100.1	0.001257	100.1	25.00	0.02000
1.719	0.03000	0.002827	0.002827	100.0	0.002829	100.1	0.002827	100.0	16.67	0.03000
2.000	0.03491	0.003826	0.003828	100.1	0.003831	100.1	0.003828	100.1	14.33	0.03490
2.292	0.04000	0.005024	0.005026	100.0	0.005032	100.2	0.005027	100.1	12.50	0.03999
2.865	0.05000	0.007847	0.007852	100.1	0.007867	100.3	0.007854	100.1	10.00	0.04998
3.000	0.05236	0.008605	0.008611	100.1	0.008629	100.3	0.008613	100.1	9.554	0.05234
4.000	0.06981	0.01529	0.01531	100.1	0.01536	100.5	0.01531	100.1	7.168	0.06976
5.000	0.08727	0.02386	0.02391	100.2	0.02405	100.8	0.02392	100.3	5.737	0.08716
5.730	0.1000	0.03131	0.03139	100.3	0.03163	101.0	0.03142	100.4	5.008	0.09983
10.00	0.1745	0.09473	0.09546	100.8	0.09768	103.1	0.09570	101.0	2.879	0.1736
11.46	0.2000	0.1240	0.1252	101.0	0.1291	104.1	0.1257	101.4	2.517	0.1987
15.00	0.2618	0.2104	0.2141	101.8	0.2256	107.2	0.2153	102.3	1.932	0.2588
17.19	0.3000	0.2744	0.2806	102.3	0.3006	109.5	0.2827	103.0	1.692	0.2955
22.92	0.4000	0.4764	0.4960	104.1	0.5616	117.9	0.5027	105.5	1.284	0.3894
28.65	0.5000	0.7221	0.7692	106.5	0.9376	129.8	0.7854	108.8	1.043	0.4794
30.00	0.5236	0.7854	0.8418	107.2	1.047	133.3	0.8613	109.7	1.000	0.5000
34.38	0.6000	1.002	1.097	109.5	1.470	146.7	1.131	112.9	0.8855	0.5846
40.11	0.7000	1.306	1.478	113.3	2.229	170.9	1.539	118.0	0.7761	0.6462
45.00	0.7854	1.571	1.840	117.1	3.142	200.0	1.938	123.4	0.7071	0.7071
45.84	0.8000	1.617	1.906	117.9	3.331	206.0	2.011	124.4	0.6970	0.7174
51.57	0.9000	1.928	2.377	123.3	4.989	258.8	2.565	132.0	0.6383	0.7833
57.30	1.0000	2.224	2.888	129.9	7.620	342.6	3.142	141.3	0.5942	0.8415
60.00	1.0472	2.356	3.142	133.4	9.425	400.0	3.445	146.2	0.5774	0.8660
63.03	1.1000	2.495	3.433	137.6	12.13	486.2	3.801	152.3	0.5610	0.8912
68.75	1.2000	2.729	4.006	146.8	20.78	761.5	4.524	165.8	0.5365	0.9320
74.48	1.3000	2.917	4.602	157.8	40.76	1,397.3	5.309	182.0	0.5189	0.9636
80.21	1.4000	3.051	5.215	170.9	105.6	3,461.2	6.158	201.8	0.5074	0.9855
85.94	1.5000	3.126	5.839	186.8	624.7	19,984.0	7.069	226.1	0.5013	0.9975
90.00	1.5708	3.142	6.283	200.0	$\infty$	$\infty$	7.752	246.7	0.5000	1.0000

\*Each percent-of- $\Omega$  column tabulates the percent of  $\Omega$  for the column immediately preceding.

†That is,  $\omega/\Omega$  x 100,  $\pi \tan^2 \theta_h/\Omega$  x 100,  $\pi \theta_h^2/\Omega$  x 100, respectively.

\*\*Last-column values must be multiplied by the index of refraction  $n$  to obtain N.A.

## References

- [1] Walther, A., "Radiometry and Coherence", J. Opt. Soc. Am. 58, No. 9, 1256-1259 (Sept. 1968).
- [2] Walther, A., "Radiometry and Coherence", J. Opt. Soc. Am. 63, No. 12, 1622-1623 (Dec. 1973).
- [3] Marchand, E. W. and Wolf, E., "Radiometry with Sources of any State of Coherence", J. Opt. Soc. Am. 64, No. 9, 1219-1226 (Sept. 1974).
- [4] Marchand, E. W., and Wolf, E., "Walther's Definitions of Generalized Radiance", J. Opt. Soc. Am. 64, No. 9, 1273-1274 (Sept. 1974); and Walther, Adriaan, "Reply to Marchand and Wolf", *ibid.*, p. 1275.
- [5] "International Lighting Vocabulary", 3rd Edition, common to the CIE and IEC (International Electrotechnical Commission), International Commission on Illumination (CIE), Bureau Centrale de la CIE, 4 Av. du Recteur Poincaré, 75-Paris 16<sup>e</sup>, France, Publication CIE No. 17 (E-1.1.) (1970).
- [6] Nicodemus, Fred E., "Optical Resource Letter on Radiometry", J. Opt. Soc. Am. 59, No. 3, 243-248 (March 1969); also Am. J. Phys. 38, No. 1, 43-50 (Jan. 1970); also reprinted in [29].
- [7] Jones, R. Clark, "Appendix [on Radiometry]", pp. 19-36 of "Atmospheric Transmission: Concepts, Symbols, Units and Nomenclature", by Spiro, Jones, and Wark, Infrared Physics 5, No. 1, 11-36 (March 1965); also reprinted in [29], where a number of unfortunate typographical errors have been corrected.
- [8] Nicodemus, Fred E., "Radiance", Am. J. Phys. 31, No. 5, 368-377 (May 1963).
- [9] DeWitt, D. P., and Richmond, J. C., "Theory and Measurement of the Thermal Radiative Properties of Metals", a chapter in "Techniques of Metals Research", series ed. R. R. Bunshah, Vol. IV, Part 1, "Measurement of Physical Properties. Part 1 Some Special Properties", ed. E. Passaglia, (Wiley-Interscience, New York, N. Y., 1972).
- [10] Liebes, Sydney, Jr., "Brightness -- On the Ray Invariance of  $B/n^2$ ", Am. J. Phys. 37, No. 9, 932-934 (Sept. 1969).
- [11] Steel, W. H., "Luminosity, Throughput, or Etendue?", Appl. Opt. 13, No. 4, 704-705 (April 1974).
- [12] Zachor, A., "Throughput: A Figure of Merit for Optical Systems", J. Opt. Soc. Am. 54, No. 1, p. iv (Adv. of Block Engineering, Inc.) (Jan. 1964).
- [13] Jones, R. Clark, "Immersed Radiation Detectors", Appl. Opt. 1, No. 5, 607-613 (Sept. 1962).
- [14] Jenkins, Francis A., and White, Harvey E., "Fundamentals of Optics", 3rd ed. (McGraw-Hill, New York, N. Y., 1957).
- [15] Ditchburn, R. W., "Light", Vol. 1, 2nd ed. (John Wiley-Interscience, New York, N. Y., 1963).
- [16] Page, Chester H., and Vigoureux, Paul, Eds., "The International System of Units (SI)", Nat. Bur. Stand. (U.S.), Spec. Publ. 330, 43 pages, (July 1974).
- [17] Jones, R. Clark, "Terminology in Photometry and Radiometry", J. Opt. Soc. Am. 53, No. 11, 1314-1315 (Nov. 1963); also reprinted in [29].

- [18] "American National Standard -- Letter Symbols for Units Used in Science and Technology", ANSI Y10.19--1969 (Revision of USAS Y10.19--1967)(IEEE No. 260), The American Society of Mechanical Engineers, 345 East 47th Street, New York, N. Y. 10017.
- [19] Moon, Parry and Spencer, Domina Eberle, "A Study of Photometric Nomenclature", J. Opt. Soc. Am. 36, 666-675 (1946).
- [20] Nusselt, W., Z. Ver. deut. Ing. 72, 673 (1928).
- [21] Jakob, Max, "Heat Transfer -- Vol. II" (Wiley, 1957) (See Fig. 31-35 on p. 66).
- [22] Seibert, O., Arch. Wärmewirt. 9, 180 (1928).
- [23] Gershun, A., "The Light Field", Moscow (1936); English translation by Parry Moon and Gregory Timoshenko, J. Math. Phys. 18, 51-151 (May 1939) (MIT, Elect. Eng. Dept. Contrib. No. 164, 1939).
- [24] Wiener, Christian, "Lehrbuch der darstellenden Geometrie", Leipzig, 1884 (Vol. I, Chapter on "Bleuchtungslehre mit ihrer Anwendung auf evenflachige Körper".)
- [25] Several such devices are described on pp. 67-70 of [21].
- [26] Sumpner, W. E., Proc. Phys. Soc. (London) 12, 10 (1892); also Phil. Mag. 35, 81 (1893).
- [27] Nicodemus, Fred E., "Emissivity of Isothermal Spherical Cavity with Gray Lambertian Walls", Appl. Opt. 7, No. 7, 1359-1362 (July 1968); see Appendix, pp. 1361-1362.
- [28] Sears, Francis W., "Optics", 3rd ed. (Addison-Wesley, Reading, Mass., 1949).
- [29] Nicodemus, Fred E., "Radiometry -- Selected Reprints", published for the American Association of Physics Teachers (AAPT) by the American Institute of Physics (AIP), New York, N. Y., (July 1971). Included are reprints of [6,7,17].

U.S. DEPT. OF COMM. <b>BIBLIOGRAPHIC DATA SHEET</b>	1. PUBLICATION OR REPORT NO. NBS TN 910-1	2. Gov't Accession No.	3. Recipient's Accession No.
4. TITLE AND SUBTITLE - SELF-STUDY MANUAL ON OPTICAL RADIATION MEASUREMENTS -- Part I -- Concepts Chapter 1. Introduction Chapter 2. Distribution of Optical Radiation with respect to Position and Direction Chapter 3. Spectral Distribution of Optical Radiation		5. Publication Date March 1976	
7. AUTHOR(S) Fred E. Nicodemus, Henry J. Kostkowski, and Albert T. Hattenburg		6. Performing Organization Code	
9. PERFORMING ORGANIZATION NAME AND ADDRESS  NATIONAL BUREAU OF STANDARDS DEPARTMENT OF COMMERCE WASHINGTON, D.C. 20234		8. Performing Organ. Report No.	
12. Sponsoring Organization Name and Complete Address (Street, City, State, ZIP)  Same as No. 9		10. Project/Task/Work Unit No.	
15. SUPPLEMENTARY NOTES		11. Contract/Grant No.	
12. Sponsoring Organization Name and Complete Address (Street, City, State, ZIP)		13. Type of Report & Period Covered	
16. ABSTRACT (A 200-word or less factual summary of most significant information. If document includes a significant bibliography or literature survey, mention it here.)  This is the initial publication of a new series of Technical Notes (910) entitled "A Self-Study Manual on Optical Radiation Measurements." It contains the first three chapters of this Manual. Additional chapters will be published, similarly, as they are completed. The Manual is a definitive tutorial treatment of the measurement of incoherent optical radiation that is complete enough for self instruction. Detailed chapter summaries make it also a convenient authoritative reference source.  The first chapter is an introduction that includes a description of optical radiation and the ray approach to its treatment in this Manual (based on geometrical optics), a discussion of relevant parameters and their use in a measurement equation as a systematic technique for analyzing measurement problems, and a presentation of the system of units and nomenclature used.  The second chapter, on the distribution of optical radiation with respect to position and direction, introduces the basic radiometric quantity, radiance, and its important invariance properties. It is shown how to determine the total power in a beam from the radiance distribution and to determine the distribution of radiance at any surface, through which the beam passes, in terms of the distribution at any other surface that also intersects the entire beam.		14. Sponsoring Agency Code	
17. KEY WORDS (six to twelve entries; alphabetical order; capitalize only the first letter of the first key word unless a proper name; separated by semicolons)  Optical radiation measurement; photometry; radiometry; spectroradiometry.			
18. AVAILABILITY <input checked="" type="checkbox"/> Unlimited  <input type="checkbox"/> For Official Distribution. Do Not Release to NTIS  <input checked="" type="checkbox"/> Order From Sup. of Doc., U.S. Government Printing Office Washington, D.C. 20402, SD Cat. No. C13, 46-910-1  <input type="checkbox"/> Order From National Technical Information Service (NTIS) Springfield, Virginia 22151		19. SECURITY CLASS (THIS REPORT)  UNCLASSIFIED	21. NO. OF PAGES  93
		20. SECURITY CLASS (THIS PAGE)  UNCLASSIFIED	22. Price  \$2.10

The third chapter, on the spectral distribution of optical radiation, develops the concept of spectral radiance. Its invariance properties and the evaluation of flux in a beam from a known distribution of spectral radiance are developed in a treatment paralleling that for radiance in Chapter 2.

These are the first chapters of Part I, in which are developed the basic concepts, essential for the subsequent discussions of instrumentation in Part II, and of applications in Part III.







# NBS TECHNICAL PUBLICATIONS

## PERIODICALS

**JOURNAL OF RESEARCH** reports National Bureau of Standards research and development in physics, mathematics, and chemistry. It is published in two sections, available separately:

### • Physics and Chemistry (Section A)

Papers of interest primarily to scientists working in these fields. This section covers a broad range of physical and chemical research, with major emphasis on standards of physical measurement, fundamental constants, and properties of matter. Issued six times a year. Annual subscription: Domestic, \$17.00; Foreign, \$21.25.

### • Mathematical Sciences (Section B)

Studies and compilations designed mainly for the mathematician and theoretical physicist. Topics in mathematical statistics, theory of experiment design, numerical analysis, theoretical physics and chemistry, logical design and programming of computers and computer systems. Short numerical tables. Issued quarterly. Annual subscription: Domestic, \$9.00; Foreign, \$11.25.

**DIMENSIONS/NBS** (formerly *Technical News Bulletin*)—This monthly magazine is published to inform scientists, engineers, businessmen, industry, teachers, students, and consumers of the latest advances in science and technology, with primary emphasis on the work at NBS. The magazine highlights and reviews such issues as energy research, fire protection, building technology, metric conversion, pollution abatement, health and safety, and consumer product performance. In addition, it reports the results of Bureau programs in measurement standards and techniques, properties of matter and materials, engineering standards and services, instrumentation, and automatic data processing.

Annual subscription: Domestic, \$9.45; Foreign, \$11.85.

## NONPERIODICALS

**Monographs**—Major contributions to the technical literature on various subjects related to the Bureau's scientific and technical activities.

**Handbooks**—Recommended codes of engineering and industrial practice (including safety codes) developed in cooperation with interested industries, professional organizations, and regulatory bodies.

**Special Publications**—Include proceedings of conferences sponsored by NBS, NBS annual reports, and other special publications appropriate to this grouping such as wall charts, pocket cards, and bibliographies.

**Applied Mathematics Series**—Mathematical tables, manuals, and studies of special interest to physicists, engineers, chemists, biologists, mathematicians, computer programmers, and others engaged in scientific and technical work.

**National Standard Reference Data Series**—Provides quantitative data on the physical and chemical properties of materials, compiled from the world's literature and critically evaluated. Developed under a world-wide

program coordinated by NBS. Program under authority of National Standard Data Act (Public Law 90-396).

**NOTE:** At present the principal publication outlet for these data is the *Journal of Physical and Chemical Reference Data* (JPCRD) published quarterly for NBS by the American Chemical Society (ACS) and the American Institute of Physics (AIP). Subscriptions, reprints, and supplements available from ACS, 1155 Sixteenth St. N. W., Wash. D. C. 20056.

**Building Science Series**—Disseminates technical information developed at the Bureau on building materials, components, systems, and whole structures. The series presents research results, test methods, and performance criteria related to the structural and environmental functions and the durability and safety characteristics of building elements and systems.

**Technical Notes**—Studies or reports which are complete in themselves but restrictive in their treatment of a subject. Analogous to monographs but not so comprehensive in scope or definitive in treatment of the subject area. Often serve as a vehicle for final reports of work performed at NBS under the sponsorship of other government agencies.

**Voluntary Product Standards**—Developed under procedures published by the Department of Commerce in Part 10, Title 15, of the Code of Federal Regulations. The purpose of the standards is to establish nationally recognized requirements for products, and to provide all concerned interests with a basis for common understanding of the characteristics of the products. NBS administers this program as a supplement to the activities of the private sector standardizing organizations.

**Federal Information Processing Standards Publications (FIPS PUBS)**—Publications in this series collectively constitute the Federal Information Processing Standards Register. Register serves as the official source of information in the Federal Government regarding standards issued by NBS pursuant to the Federal Property and Administrative Services Act of 1949 as amended, Public Law 89-306 (79 Stat. 1127), and as implemented by Executive Order 11717 (38 FR 12315, dated May 11, 1973) and Part 6 of Title 15 CFR (Code of Federal Regulations).

**Consumer Information Series**—Practical information, based on NBS research and experience, covering areas of interest to the consumer. Easily understandable language and illustrations provide useful background knowledge for shopping in today's technological marketplace.

**NBS Interagency Reports (NBSIR)**—A special series of interim or final reports on work performed by NBS for outside sponsors (both government and non-government). In general, initial distribution is handled by the sponsor; public distribution is by the National Technical Information Service (Springfield, Va. 22161) in paper copy or microfiche form.

Order NBS publications (except NBSIR's and Bibliographic Subscription Services) from: Superintendent of Documents, Government Printing Office, Washington, D.C. 20402.

## BIBLIOGRAPHIC SUBSCRIPTION SERVICES

The following current-awareness and literature-survey bibliographies are issued periodically by the Bureau: Cryogenic Data Center Current Awareness Service

A literature survey issued biweekly. Annual subscription: Domestic, \$20.00; foreign, \$25.00.

Liquefied Natural Gas. A literature survey issued quarterly. Annual subscription: \$20.00.

Superconducting Devices and Materials. A literature

survey issued quarterly. Annual subscription: \$20.00. Send subscription orders and remittances for the preceding bibliographic services to National Bureau of Standards, Cryogenic Data Center (275.02) Boulder, Colorado 80302.

Electromagnetic Metrology Current Awareness Service Issued monthly. Annual subscription: \$24.00. Send subscription order and remittance to Electromagnetics Division, National Bureau of Standards, Boulder, Colo. 80302.

**U.S. DEPARTMENT OF COMMERCE**  
**National Bureau of Standards**  
Washington, D.C. 20234

OFFICIAL BUSINESS

Penalty for Private Use, \$300

POSTAGE AND FEES PAID  
U.S. DEPARTMENT OF COMMERCE  
COM-215



SPECIAL FOURTH-CLASS RATE  
BOOK



**75 YEARS**  
**NBS**  
1901-1976